



Operation and Installation Manual

EFOY Pro 12000 Duo

EN

Contents

Contents.....	1
1 Introduction	4
1.1 Foreword	4
1.2 Contact details	4
2 Safety Information	5
2.1 Explanation of safety alert signal words.....	5
2.2 General safety instructions.....	6
2.3 Safety instructions for methanol	8
2.4 Correct use	10
2.5 Certification	11
2.6 Warranty.....	12
2.7 Disposal and Transportation.....	13
3 Configuration.....	14
3.1 Standard equipment	14
3.2 Connections	15
3.3 Specifications.....	18
4 Installation.....	21
4.1 Installation space requirements.....	21
4.2 Mounting the fuel cell	25
4.3 Off-heat.....	26
4.4 Connecting the exhaust hose	27
4.5 Fill in EFOY Initial Start Fluid.....	29
4.6 Electrical connection	31
4.6.1 Electrical connection to the battery	32
4.6.2 Combination with other energy sources	34
5 Operation	35
5.1 Operation via the operating panel.....	35
5.1.1 Buttons and symbols on the operating panel.....	35
5.1.2 Initial start.....	37

5.1.3	Info screen	39
5.1.4	Main menu.....	42
5.1.5	Expert menu.....	44
5.2	Remote control via computer	53
5.3	Fuel cartridges	54
5.3.1	Connecting the fuel cartridge.....	54
5.3.2	Selecting a fuel cartridge	56
5.4	Operating modes.....	58
5.4.1	Automatic	58
5.4.2	Manual On	59
5.4.3	Manual Off	60
5.4.4	External control	61
5.4.5	Hybrid.....	62
5.5	Automatic antifreeze mode.....	63
5.6	Shutdown	64
5.6.1	Switching off the fuel cell.....	64
5.6.2	Removing the EFOY fuel cartridge	64
5.6.3	Secure transportation and storage procedure.....	64
5.6.4	Detaching the charge line and data line	65
5.6.5	Detaching the exhaust hose	65
6	Maintenance	66
6.1	Service	66
6.2	Long term storage	66
6.3	Firmware update	67
6.4	Cleaning.....	67
7	Troubleshooting	68
7.1	Safety.....	68
7.2	Errors and solutions	69
7.2.1	Error message on the display	69
7.2.2	Display Warnings.....	71
7.2.3	Errors without display messages.....	72
7.3	Adding EFOY recovery fluid.....	73

8	Data Interface and Optional Accessories	75
8.1	Data interface functionality.....	75
8.2	Communication Protocols.....	77
	Data interfaces	77
8.2.1	Modbus RTU	78
8.2.2	SIO / Plain text.....	88
8.3	GSM-Modem	89
8.4	Fuel cartridge sensor FS1	90
8.5	Cluster Controller CC1	91
8.6	DuoCartSwitch DCS 1.....	93
9	Appendix.....	94
9.1	Installation Checklist	94
9.2	U-I and U-P characteristic	95
9.3	Output power characteristic	96

1 Introduction

1.1 Foreword

Thank you for choosing an EFOY Pro fuel cell from SFC Energy AG. We hope you enjoy using your new energy supply system.

Before you use the fuel cell for the first time, please read this user manual and follow the installation instructions.

Please contact your distributor in case you have questions about installation or operation.

Copyright by SFC Energy AG 2016. All rights reserved. Subject to change without notice.

1.2 Contact details

SFC Energy AG

Eugen-Saenger-Ring 7

85649 Brunnthal

Germany

Hotline: +49 89 / 673 592 555

Freecall*: 00800 / 732 762 78

eMail: service@sfc.com

Web: www.efoy-pro.com

*Calls can be placed free of charge from the landline from: Germany, Belgium, Denmark, France, Great Britain, Italy, the Netherlands, Norway, Austria, Sweden, Switzerland and Spain.

2 Safety Information

2.1 Explanation of safety alert signal words

**DANGER!**

Indicates an imminently hazardous situation, which, if not avoided, poses a high risk of death or serious physical injury.

**WARNING!**

Indicates a potentially hazardous situation, which, if not avoided, poses a medium risk of death or serious physical injury.

**CAUTION!**

Indicates a hazardous situation, which, if not avoided, poses a slight risk of mild or moderate physical injury or damage to property.

**INFO:**

Important information for the operator or user of the system.

2.2 General safety instructions

Read the user manual before commissioning the fuel cell, and keep the user manual close to the device at all times.

Follow all of the instructions in this user manual.



For indoor use only. Use the EFOY Pro fuel cell only in housings with protection against water and dust.



The EFOY Pro fuel cell must not be opened.

The EFOY fuel cartridge must not be opened or refilled using excessive force.

Modifications to the device constitute a safety hazard and may result in the loss of your operating license and nullify your warranty and guarantee.

Use original EFOY accessories only.



EFOY Pro fuel cells and EFOY fuel cartridges must not be stored and operated at temperatures over +50 °C / +122 °F.

Protect from heat and direct sunlight.

Operate the EFOY Pro fuel cell only as specified in the installation instructions, and in a well-ventilated space.



Keep EFOY Pro fuel cells that have been switched off in frost-free storage or use the automatic antifreeze feature.



Do not smoke in the vicinity of the EFOY Pro fuel cell or EFOY fuel cartridge. Protect from heat and ignition sources. Methanol is highly flammable!



Keep all EFOY Pro fuel cells and EFOY fuel cartridges out of reach of children, even when empty or only partly full.



WARNING!

In exceptional cases, the exhaust gases emitted by the device may contain substances that are harmful to health!

Do not inhale exhaust gases directly for prolonged periods. Instead, use the exhaust tube provided to route the exhaust gas into the open air.



WARNING!

Damage in the event of an accident; risk of injury!

EFOY Pro fuel cells and EFOY fuel cartridges must be securely fastened to prevent damage in the event of an accident.



WARNING!

EFOY Pro fuel cells must not be used in potentially explosive atmospheres.



CAUTION!

Burn Hazard.

Hot surfaces. In operation temperature up to +65 °C / +150 °F at heat exchanger possible. Do not touch.



CAUTION!

The EFOY Pro fuel cell is not water-tight!

Ensure that no water can enter the fuel cell.



CAUTION!

Improper use or improper connection to other electrical equipment may lead to damage.

2.3 Safety instructions for methanol

**INFO:**

There is no risk of you coming into contact with methanol provided that you handle the device and fuel cartridges in accordance with the instructions.

**DANGER!**

Leakage of methanol fumes poses a fire hazard! Do not smoke when replacing the EFOY fuel cartridge and do not expose it to other ignition sources! Protect EFOY fuel cartridges from temperatures exceeding +50 °C / +122 °F.

Leakage of a small quantity of methanol will evaporate, leaving no residue.

**WARNING!**

Methanol is highly flammable!

You receive methanol in safe, tested EFOY fuel cartridges, which prevent the contents from escaping if used correctly.

The storage and transport of methanol may be subject to statutory regulations.

For more information, refer to the safety data sheet on methanol, available on our website at <http://www.efoy-pro.com>.

**WARNING!**

Methanol is toxic when inhaled, swallowed or allowed to come into contact with the skin. Inhaling and swallowing methanol, or allowing it to come into contact with your skin carries a serious risk of irreversible damage.

Call a doctor immediately if you have direct physical contact with the substance, in the event of an accident, or if you feel unwell, and show the doctor the fuel cartridge label or the methanol safety data sheet.



CAUTION!

Impurities in methanol!

Original EFOY fuel cartridges contain methanol that has been approved by SFC. Even slight impurities or foreign particles in commercially available methanol may cause irreversible damage to the device, and may nullify the warranty or guarantee.

Use only original EFOY fuel cartridges!

2.4 Correct use

The EFOY devices produced by SFC Energy AG are automatic charging devices for 24 V or 48 V lead accumulators (batteries) or SFC qualified lithium iron phosphate batteries (LiFePO₄). Please note the following:

- The devices must only be used to charge lead accumulators (batteries) that conform to the technical specifications of the device (see chapter 3.3 "Specifications" on page 18).
- The devices can be used according to the technical specifications for stationary and mobile operation in vehicles (see chapter 3.3 "Specifications" on page 18).
- The devices must only be operated with original EFOY fuel cartridges.
- The devices are not intended to be used as an emergency power supply for medical or life-sustaining systems.
- Connecting several devices in parallel to increase the charging current is permitted.
- Connecting several devices in series to increase the voltage is not permitted.
- Devices with a defective or damaged housing must not be operated.
- The devices are intended for industrial use.

2.5 Certification

Declaration of conformity

CE SFC Energy AG, Eugen-Saenger-Ring 7, 85649 Brunnthal, Germany, hereby declares that the EFOY Pro 12000 Duo conform to the provisions of the EC Directive on electro-magnetic compatibility (2004/108/EC). The following harmonized norms apply:

DIN EN 61000-6-1:2007, DIN EN 61000-6-3:2007 + A1:2011

FC Radio Frequency Interference (RFI) (FCC 15.109)

This equipment has been tested and found to comply with the limits for Class B digital devices pursuant to Part 15 of the FCC Rules. These limits are designed to provide reasonable protection against harmful interference in a residential environment. This equipment generates, uses, and can radiate radio frequency energy, and if not installed and used in accordance with the instruction manual, may cause harmful interference to radio communications. However, there is no guarantee that interference will not occur in a particular installation. If this equipment does cause harmful interference to radio or television reception, which can be determined by turning the equipment off and on, the user is encouraged to try and correct the interference by one or more of the following measures:

- Reorient or relocate the receiving antenna.
- Increase the separation between the equipment and the receiver.
- Consult the dealer or an experienced radio/TV technician for help.

Labeling Requirements (FCC 15.19)

This device complies with Part 15 of FCC rules. Operation is subject to the following two conditions:

(1) this device may not cause harmful interference, and (2) this device must accept any interference received, including interference that may cause undesired operation.

Modifications (FCC 15.21)

Changes or modifications to this equipment not expressly approved by SFC Energy AG may void the user's authority to operate this equipment.

Industry Canada Compliance Statement

This digital apparatus does not exceed the Class B limits for radio noise for digital apparatus set out in the interference-causing equipment standard entitled: "Digital Apparatus", ICES-003 of Industry Canada.

Cet appareil numérique respecte les limites de bruits radioélectriques applicables aux appareils numériques de Classe B prescrites dans la norme sur le matériel brouilleur : "Appareils numériques", NMB-003 édictée par Industrie Canada.

Seals of approval



The devices have been tested for electro-magnetic compatibility in accordance with ECE Regulation No. 10, and have been approved for use in motor vehicles.

Approval number: E24 10R-051962



The devices have undergone voluntarily testing by TÜV SÜD AG for conformity with the basic requirements of IEC 62282-3, and have been awarded the seal of approval for product safety.



This product is intended and certified for Canada and the USA. The product was voluntarily tested according to the safety requirements:

UL 60950-1:2007/R2014-10;

CAN/CSA C22.2 No. 60985-1:2007/A2:2014-10;

ANSI/CSA FC 1:2014;

CAN/CSA-C22.2 No. 62282-3-100-15

2.6 Warranty

The warranty period begins with the purchase of a new device. You can use your sales receipt as proof of this date. Please keep these documents safe. Our warranty services are based on the warranty conditions of SFC Energy AG that are valid for the relevant country at the time of purchase. Please note the attached conditions of warranty.

Service

Please contact our EFOY hotline in relation to any technical questions about EFOY Pro fuel cells. The contact details are provided in chapter 1.2 "Contact details" on page 4.

2.7 Disposal and Transportation

Packaging

Your new device was packaged to ensure that it reached you safely. All materials used in the packaging are environmentally friendly and can be re-used.

We recommend that you keep the packaging in case it is needed for winter storage.

However, if you wish to dispose of the packaging, please help our planet by disposing of it in an environmentally responsible way and in accordance with the applicable local regulations.

Please note the instructions provided by SFC Energy AG when transporting the device. For information on this, refer to our website or contact the EFOY hotline. The contact details are provided in chapter 1.2 "Contact details" on page 4.



WARNING!

Plastic wrapping and cardboard boxes pose a risk of suffocation!

Please keep all packaging out of reach of children.

Fuel cartridges

Completely empty fuel cartridges can be disposed of with your plastic waste. Dispose of partly full fuel tanks in the same way as other hazardous waste, such as solvents and paint.

Old devices

Old devices are more than just worthless rubbish! Environmentally responsible disposal can reclaim valuable raw materials, while protecting the environment.

Old electronic devices must not be disposed of in your household rubbish. Observe the local regulations.

For advice on returning old devices, please contact the EFOY hotline. The contact details are provided in chapter 1.2 "Contact details" on page 4.

3 Configuration

3.1 Standard equipment

The EFOY Pro fuel cell SET includes the following equipment:

Part number	Description	Qty
-	Device EFOY Pro fuel cell	1
500 904 001	Insulated exhaust hose EH2	1
500 903 001	EFOY Initial Start Fluid 1.5l	1
500 903 002	EFOY Recovery Fluid 0.5 l	2
500 901 001	User manual EFOY Pro 12000 Duo	1



WARNING!

Use original EFOY accessories only!

Use of unauthorized parts compromises safety and renders the warranty null and void.

A complete list of accessories and spare parts is available at www.efoy-pro.com.

3.2 Connections

Front view	
1.	Operation panel (see detail view)
2.	Opening screw for EFOY fluids
3.	Data interface (see detail view)
4.	Connector #1 for EFOY fuel cartridge
5.	Connector #2 for EFOY fuel cartridge
6.	Outlet screw for internal fluid (for transport), bottom side
7.	Air supply for cooling air
Back view	
8.	Off-heat from heat exchanger
9.	Data interface reverse side (see detail view)
10.	Electrical connection (see detail view)
11.	Connection for exhaust hose

Detail view – Operation panel

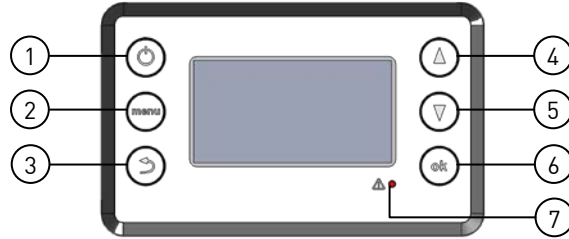

1.		Switch EFOY Pro fuel cell on/off
2.	[menu]	Display the main menu.
3.	[↶]	Scroll back one level in the menu.
4.	[▲]	Scroll up one line in the display.
5.	[▼]	Scroll down one line in the display.
6.	[ok]	<ul style="list-style-type: none"> • Open the selected menu. • Confirm a selection.
7.		Red LED lights up to indicate a fault.

Detail view – Data interface front side

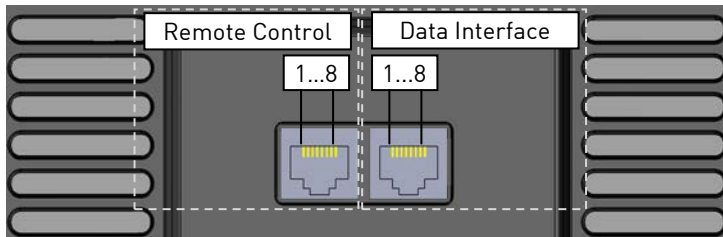

Remote Control		Data Interface	
1.	DuoCartSwitch (10 VDC)	1.	DuoCartSwitch (10 VDC)
2.	TxD (Operation panel OP2)	2.	TxD (RS232 Data)
3.	RxD (Operation panel OP2)	3.	RxD (RS232 Data)
4.	GND, Ground	4.	GND, Ground
5.	+12 VDC	5.	+12 VDC
6.	Fuel Cartridge Sensor (10 VDC)	6.	Fuel Cartridge Sensor (10 VDC)
7.	Remote On	7.	Remote On
8.	M/S (Master/Slave) & Hybrid	8.	M/S (Master/Slave) & Hybrid

Detail view – Electrical connection

The diagram shows a top-down view of the electrical connection panel. It features four terminals labeled 1, 2, 3, and 4. Terminals 1 and 2 are grouped under the label 'SENSE', and terminals 3 and 4 are grouped under 'POWER'. To the right of these terminals is a separate terminal labeled 5, which is connected to an earth symbol (a circle with a vertical line and three horizontal lines below it).

1.	Connection sense line +
2.	Connection power line +
3.	Connection power line -
4.	Connection sense line -
5.	Connection earth line

Detail view – Data interface reverse side – I/O

The diagram shows the reverse side of the data interface panel. It features two MODBUS RS485 ports, each with a terminal block labeled '1...8'. To the right is a larger 'COMMUNICATION' port with terminals labeled '3 ... 11'. Below the terminal blocks are circular symbols representing screws or mounting points.

A	RS485	B	RS485	1.	RS232 GND
1	-	1	-	2.	RS232 TxD
2	-	2	-	3.	RS232 RxD
3	-	3	-	4.	MODBUS ISOCOM
4	RS485 MODBUS B	4	RS485 MODBUS B	5.	MODBUS B
5	RS485 MODBUS A	5	RS485 MODBUS A	6.	MODBUS A
6	-	6	-	7.	-
7	-	7	-	8.	-
8	MODBUS ISOCOM	8	MODBUS ISOCOM	9.	-

3.3 Specifications

Performance data

Product	EFOY Pro 12000 Duo	
Max. rated output	500 W	
Min. power output 3,000 h ¹	400 W	
Min. power output 4,500 h ¹	350 W	
Nominal voltage	24 V DC	48 V DC
Voltage range	18.5 V – 33 V DC	36 V – 60 V DC
Max. charging current at 500 W	24 V DC: 20.83 A	48 V DC: 10.42 A
Min. charging current at 400 W ¹	24 V DC: 16.67 A	48 V DC: 8.33 A
Recommended battery capacity ²	24 V DC: 80 - 200 Ah	48 V DC: 40 - 100 Ah
Switch-on voltage for automatic battery charging at 24 V / 48 V DC ³	24.4 V	48.8 V
Switch-off voltage for automatic battery charging at 24 V / 48 V DC ³	28.8 V	57.6 V
Required starting voltage at 24 V / 48 V DC	18.5 V	36 V
Max. battery voltage at 24 V / 48 V DC	31 V (Anti freeze mode up to 32 V)	59.5 V (Anti freeze mode up to 60 V)
Nominal consumption ⁴	0.9 l/kWh / 0.2 gallons/kWh	
Quiescent power consumption at 24 V / 48 V DC	80 mA	40 mA

¹ Nominal power varies by $\pm 10\%$, decreases linear with the operation hours. Specification valid within warranty period.

² Depends on battery type and application - bigger batteries possible if charging current sufficient for battery (e.g. solar batteries).

³ Factory setting - can be modified at operation panel or interface adapter and PC.

⁴ Effective consumption depends on operating conditions.

All technical data at temperatures of +20 °C / +68 °F.

General data

Product	EFOY Pro 12000 Duo
Number of fuel cartridges (with DCS1)	2 (4)
Length fuel connector	70 cm / 27.6 in
Sound pressure level at a distance of 1 m / 7 m (3.3 ft / 23 ft)	<60 dB(A) / <43 dB(A)
Weight	32 kg / 70.6 lbs
Dimensions (LxWxH) With 19" bars: Without 19" bars:	640 x 482.4 x 310 mm / 25.2 x 19 x 12.2 in 640 x 441 x 310 mm / 25.2 x 17.3 x 12.2 in
Warranty	See chapter 2.6 "Warranty" on page 12.

Installation requirements

Space requirement (LxWxH)	Minimum: 1000 x 482.6 x 355.6 mm / 39.4 x 19 x 10.1 in
International protection class (IP-class)	IP 20
Inclination along the direct axis	Permanent: 10° Temporary (<10 minutes): 45°
Inclination along the quadrature axis	Permanent: 10°
Operating temperature ¹	-20 °C to +50 °C / -4 °F to +122 °F
Starting temperature	+3 °C to +50 °C / +37.4 °F to +122 °F
Storage temperature	+1 °C to +50 °C / +34 °F to +122 °F
Recommended altitude ²	Up to 4,000 m / 13,000 ft

¹ At temperatures above +40 °C / +102 °F the power output can decrease.

² During operation above 3,000 m / 9,842 ft the power output can decrease.



INFO:

All technical data tested under standard conditions. The specifications are subject to change without notice.

Equipment

Operation	Via operating panel with text display or via operating panel OP2 with text display
Data-Interface	RS232 RJ-45 plug for accessories (e.g. interface adapter)
Data-Interface Modbus RTU	RS485 RJ-45 plug and terminal block (A, B, GND)
Electrical interface Power	Terminal plus (+) and minus (-): min. 10 mm ² / 0.4 in ²
Electrical interface Sense	Terminal plus (+) and minus (-): min. 2 mm ² / 0.08 in ²
Electrical interface Earth	Terminal: min. 2 mm ² / 0.08 in ²

Fuel cartridge

Fuel cartridges	M10	M28 (only with M28 adapter)
Volume	10 liters / 2.64 gallons	28 liters / 7.4 gallons
Weight	8.4 kg / 18.5 lbs	23.4 kg / 51.6 lbs
Energy capacity	11.1 kWh	31.1 kWh
Dimensions (L x W x H)	23.0 x 19.3 x 31.8 cm / 9.0 x 7.6 x 12.5 in	42.0 x 28.0 x 36.0 cm / 16.5 x 11.0 x 14.2 in

4 Installation

4.1 Installation space requirements

Installation should be carried out by trained personnel.

Ensure that there is sufficient unoccupied space behind the installation area before you drill or saw any openings. Please also observe the safety information provided by the tool manufacturers.



CAUTION!

Solvents may emit fumes during sealing. Ensure that there is sufficient ventilation and follow the instructions for using the sealing compound.



When choosing a location in which to install the fuel cell, please remember that the permitted operating temperature range for the device is -20°C to +50 °C / -4°F to +122 °F.



CAUTION!

If the temperatures in the installation space exceed +50 °C / +122 °F the EFOY Pro fuel cell will shut down and not produce energy.

As soon as the temperature in the installation space fall below +40 °C / +104 °F the EFOY Pro 12000 Duo will start again fully automatic.



CAUTION!

The device requires an air supply and generates off-heat and exhaust gases. The off-heat and exhaust gases must be released into the open air.

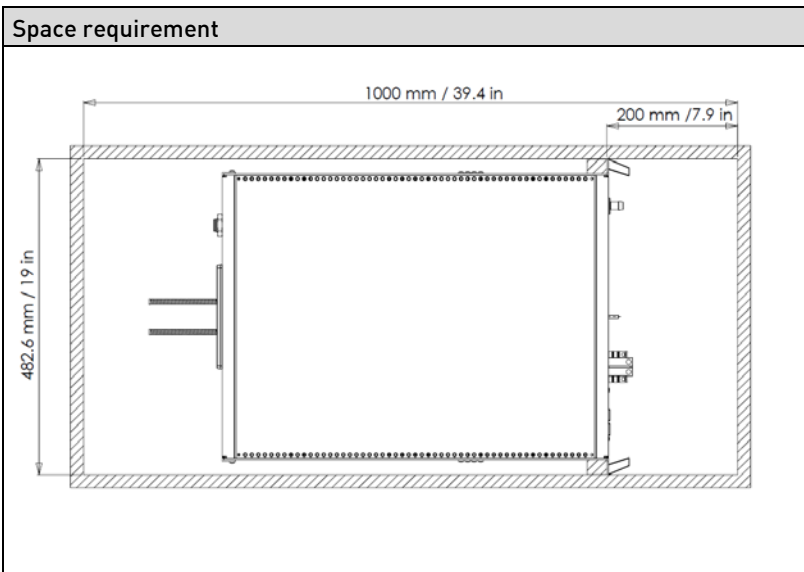
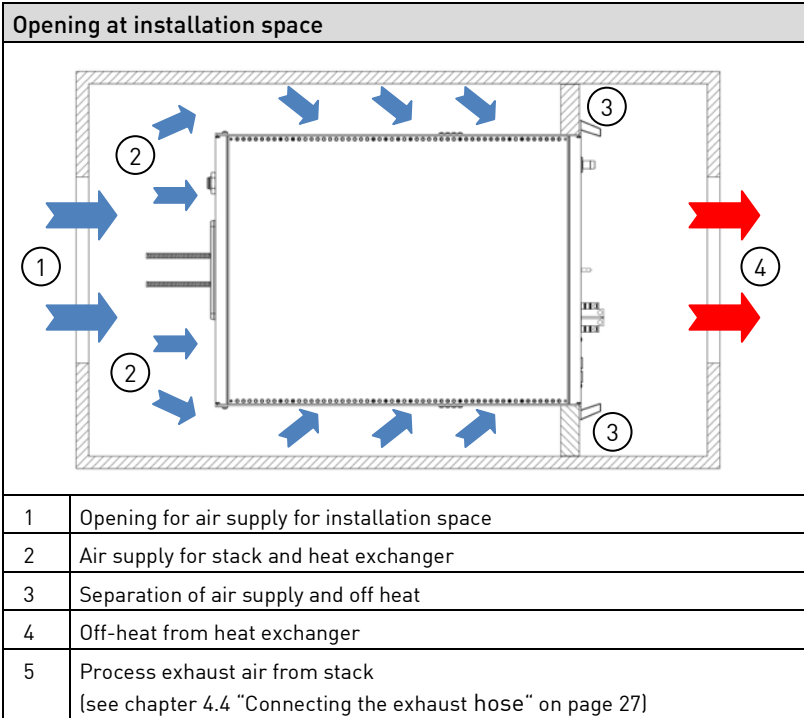

- The space in which the device is to be installed (including safety distance) must be at least LxWxH: 1000 x 482.6 x 355.6 mm / 39.4 x 19 x 10.1 in (8HE)
- If the fuel cell is installed within a sealed container, provide an opening for supply air with an opening of at least 600 cm² / 95 in² – at structured openings (fine grid, narrow gap), accordingly more.
- The air openings of the installation space need to be protected against the penetration of water and foreign particles (e.g. using louvered metal sheets and fly screens).
- Ensure that there is sufficient ventilation in the installation space to prevent heat build-up. This can be done with additional openings or an additional temperature-controlled fan.
- Separation of air supply and off heat is necessary to prevent recirculation of waste heat at high temperatures.
- The electrical connections, the fill opening for EFOY Recovery Fluid and the fuel cartridge must be easily accessible.

Install the device in an upright position only.

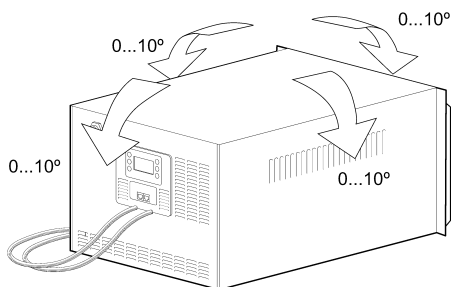

CAUTION!

Make sure that the device does not exceed the maximum inclination.

Inclination	Permanent: 10° Temporary (<10 minutes): 35°
-------------	--

Positioning the fuel cartridge

**CAUTION!**

Make sure that the device does not exceed the maximum inclination.

- When positioning the fuel cartridge, ensure that it is within reach of the fuel cartridge connection. Each connection hose is 70 cm / 27.6 in long and must not be kinked or pinched at any point.
- The EFOY Pro 12000 Duo each have two 70 cm / 27.6 in hoses. Make sure that the fuel cartridge is within reach of both connections.

**CAUTION!**

The connection hose and exhaust hose must not be damaged or replaced by another hose.

Use only original EFOY connection hoses.

4.2 Mounting the fuel cell

Select a suitable location for installation as described in chapter 4.1 "Installation space requirements" on page 21.

Observe the dimensions in chapter 3.3 "Specifications" on page 18.



DANGER!

Leakage of methanol poses a fire hazard!

Do not drill or screw into the housing. Components could be harmed and methanol could leak out.

1. Place or position the device at the desired location.
2. With the 19" rail bar the device can be mounted with screws to a 19" rack. Use 4 screws each side for mounting.

Optional the device can be mounted in other installation locations. The fixation in every direction is important for a proper operation.

4.3 Off-heat



CAUTION!

Please prove that the off heat of the heat exchanger is not led to the supply air. Separate supply air and off heat.

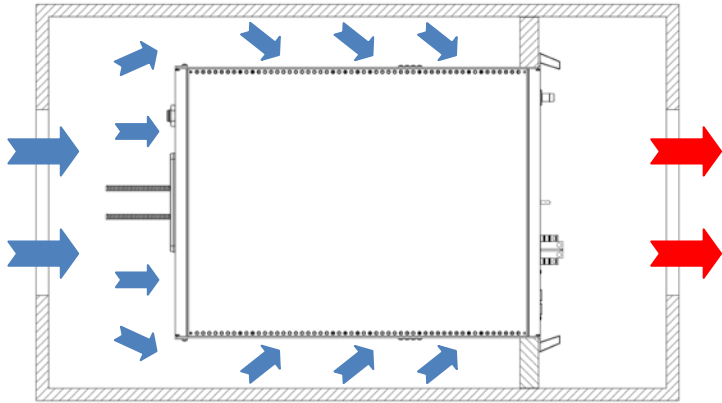

1. If the fuel cell is installed within a sealed container, provide an opening for supply air with an opening of at least 600 cm² / 95 in² – at structured openings (fine grid, narrow gap), accordingly more.
2. The air openings of the installation space need to be protected against the penetration of water and foreign particles (e.g. using louvered metal sheets and fly screens).
3. Ensure that there is sufficient ventilation in the installation space to prevent heat build-up. This can be done with additional openings or an additional temperature-controlled fan.
4. Separation of air supply and off heat is necessary to prevent recirculation of waste heat at high temperatures.
5. The electrical connections, the fill opening for EFOY fluids (EFOY Initial Start Fluid and EFOY Recovery Fluid) and the fuel cartridge must be easily accessible.

4.4 Connecting the exhaust hose



DANGER!

Within the EFOY Pro fuel cell methanol and oxygen are converted into water and carbon dioxide. This process creates heat, which needs to be conducted to the outside together with water vapor, carbon dioxide, and traces of methanol.

Avoid inhaling exhaust gases directly or for extended period, the insulated exhaust hose must be vented outside.



WARNING!

Exhaust gases contain moisture and may exceed +60°C / +140°F during operation.

Let the EFOY Pro 12000 Duo cool down before conducting a service at the unit.



WARNING!

The exhaust hose leads water vapor and water to the outside. At deep temperatures this water can freeze and harm the device.

Install an exhaust hose heater in applications with frequent cold environments below +1 °C / 34 °F to prevent freezing.

Information regarding exhaust hose heater are available at your service partner or on: www.efoy-pro.com.

Hotline: +49 89 673 592 - 555

Freecall*: 00800 732 762 78

service@sfc.com

It is possible to also collect the generated water in the installation space in a separate, vented water cartridge. Mind sufficient air supply.

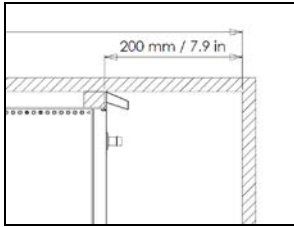

1. Remove the protective cap from the exhaust gas outlet of the EFOY Pro fuel cell. Keep this for winter storage or in case you need to return the fuel cell.

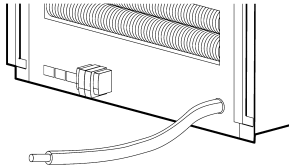

2. Attach the insulated exhaust hose supplied to the exhaust gas outlet.
3. Take measurements to determine where to drill the duct opening. The duct opening should consist of a hole with a 18 mm / 0.7 in diameter.
4. Drill a hole for the exhaust hose.

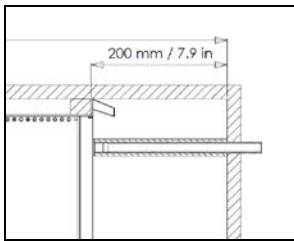

5. Feed the exhaust hose from the installation space through to the outside.
6. Use a suitable sealant to seal the hole. Ensure that the exhaust hose has no kinks or blockages and that the exhaust gases can flow freely out of it.



INFO:

Keep the exhaust hose as short as possible. The portion of the hose that penetrates outside should be no longer than 5 cm / 5.9 in. Cut the end of the hose diagonally to prevent drop formation.

The exhaust hose must not be damaged or replaced by another hose.

Take precautions to prevent the exhaust hose from freezing in winter. The exhaust hose must be no longer than 50 cm / 19.7 in. It is essential to use hose insulation in winter. The exhaust hose may be up to 100 cm / 39.4 in long for summer operation and during transitional seasons.



INFO:

Avoid siphoning in the hose as this prevents the passage of the exhaust gas.

To prevent siphoning, ensure that the hose is pointing downwards.

4.5 Fill in EFOY Initial Start Fluid



CAUTION!

Do not get in contact with the EFOY Initial Start Fluid. Wear methanol-resistant gloves and safety goggles when filling in EFOY Initial Start Fluid.

The content of the fluid is 0.5 mol/l dissolution of distilled water and methanol and is not harmful in small amounts.

For a secure transport and storage the EFOY Pro 12000 Duo is shipped empty. Therefore it is necessary to fill in EFOY Initial Start Fluid before initial operation. The content of the fluid is 0.5 mol/l dissolution of distilled water and methanol.



CAUTION!

Note that liquid can drop out when filling in EFOY initial start fluid.

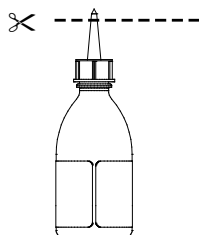

1. Use a clean pair of scissors to cut off the tip of the bottle.
2. Put on the filling tube onto the tip.



The EFOY Initial Start Fluid bottle is for one time use only.



3. Unscrew the opening screw for EFOY fluids (EFOY fluids only) with 6 mm allen key. Keep the screw close for further use.
4. Insert the tube into the connection nozzle on the device until the mark.
5. Turn the bottle upside down above the fuel cell and slowly squeeze the entire content into the opening.

6. Use a cloth to wipe away any excess EFOY Initial Start fluid that may spill over.



7. Bolt the opening screw again.



INFO:

The EFOY initial start fluid can be filled in the EFOY Pro 12000 Duo before installation. The device should not freeze after the EFOY initial start fluid was filled in.



INFO:

The EFOY Initial Start Fluid is required for every initial start. Be sure to order your next refill of EFOY initial start fluid from your specialist dealer in plenty of time.

4.6 Electrical connection



DANGER!

Danger of short circuit.

Connect the EFOY Pro 12000 Duo fuel cell only without voltage to prevent a short circuit.



DANGER!

Danger due to unbalanced charging of batteries.

Always install a battery equalizer in a serial connection of several 12 V batteries for a higher nominal voltage of 24 V DC or 48 V DC.

The responsibility of a proper installation and usage of the application underlie to the user.



WARNING!

All electrical work must only be carried out by qualified electrical technicians in accordance with the relevant legal provisions.

Laying cables incorrectly or using the wrong cable size may result in a fire hazard.

All connected cables must have sufficient insulation and adequate proof voltage, and the connectors must be scoop-proof. The laying of un-insulated cables and pins is not permitted.



CAUTION!

Compare installed circuit breaker tripping characteristics with installed battery parameters.

High battery capacities can cause high inrush currents.



INFO:

The EFOY Pro 12000 Duo must be connected to the battery using a fused circuit. Fuses have to confirm to the maximum currents as specified, see chapter 3.3 "Specifications" on page 18.

Preferably run separate lines for charging (power) and for voltage measuring (sensor) to the battery, otherwise the flow of current will cause false voltage readings.

4.6.1 Electrical connection to the battery



INFO:

The EFOY Pro charges the connected battery and the battery supplies the power to the application or to the electrical loads.

The EFOY Pro must only be used to charge batteries that conform to the technical specifications of the device (see chapter 3.3 "Specifications" on page 18).

The EFOY Pro can charge 24 V and 48 V batteries (Factory settings: lead batteries; Adjustable: LiFePO4).

The charging parameters for automatic mode can be adjusted individually using the expert menu in the operating panel (see chapter 5.1.5 "Expert menu" on page 44) or using a computer (see the user manual for the interface adapter).

The settings and parameters for LiFePO4 batteries can be found in chapter 5.1.5 "Expert menu" on page 44.

To protect the battery, the additional use of deep battery protection is recommended to disconnect the load from the battery when the battery voltage is low.

Check polarity before you connect the device.



CAUTION!

The EFOY Pro 12000 Duo needs power to measure the battery voltage as well as to start.

Take care that the EFOY Pro fuel cell is connected directly to the batteries and there is no load throw-off in between.

#	Description	Cable cross-section [mm ²]
1	Sense +	0.5 - 16 mm ² / 0.02 - 0.6 in ²
2	Power +	10 - 25 mm ² / 0.4 - 1 in ²
3	Power -	10 - 25 mm ² / 0.4 - 1 in ²
4	Sense -	0.5 - 16 mm ² / 0.02 - 0.6 in ²
5	Earth	0.5 - 16 mm ² / 0.02 - 0.6 in ²

Install a fuse / circuit breaker between the EFOY Pro 12000 Duo and the batteries in the cables sense + and power +. It should be as close as possible to the batteries.

Recommended fuse / circuit breaker Power + line:
Type B, rated current at 24 V / 48 V DC: 32 A / 16 A

Recommended fuse / circuit breaker Sense + line:
Type B, rated current at 24 V / 48 V DC: 6 A / 6 A



CAUTION!

High battery capacities can cause high inrush currents.

Compare installed fuse / circuit breaker tripping characteristics with installed battery parameters.

For a direct safety switch-off in terms of service an emergency switch should be installed in the power + cable.

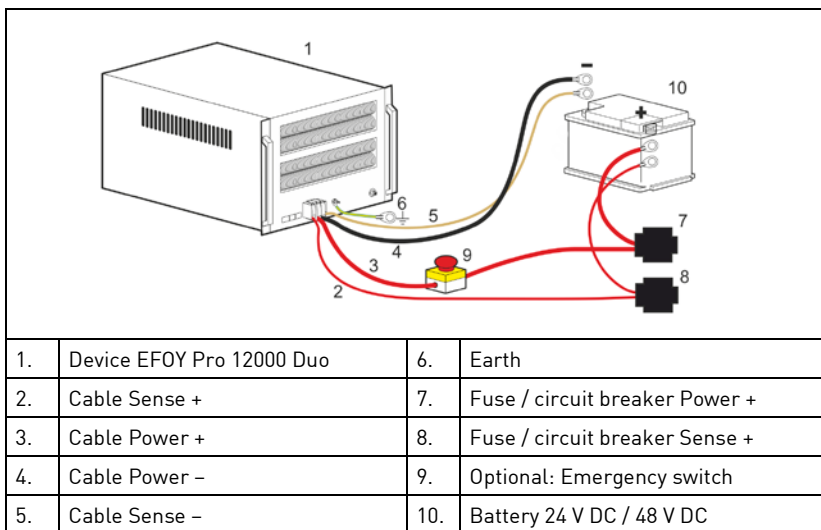

4.6.2 Combination with other energy sources

The EFOY Pro can be combined with other energy sources, which then charge the battery together. The EFOY Pro is often used in combination with a photovoltaic system.

**CAUTION!**

The EFOY Pro 12000 Duo needs power to measure the battery voltage as well as to start.

Take care that the EFOY Pro fuel cell is connected directly to the batteries and there is no load throw-off in between.

**CAUTION!**

When connecting a charge controller with temperature compensation please consider the maximum battery voltage of the EFOY Pro fuel cell (see chapter 3.3 "Specifications" on page 18).

**INFO:**

In the case of a combination with other energy sources it is recommended to adjust the switch-on thresholds of the EFOY Pro so that the device only switches on if solar alone does not provide enough energy (e.g. in winter)

5 Operation

5.1 Operation via the operating panel

5.1.1 Buttons and symbols on the operating panel

Buttons/LEDs



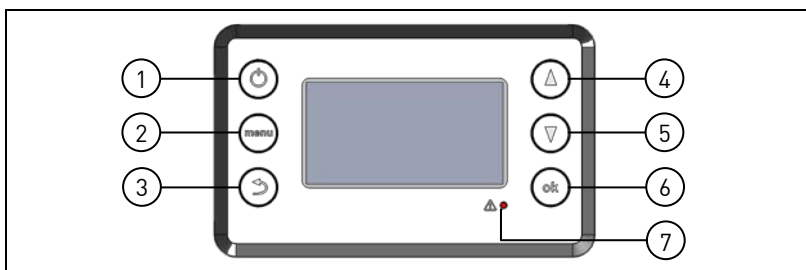







The buttons and LEDs on the operating panel have the following functions:



1.		Switch EFOY Pro fuel cell on/off
2.	[menu]	Display the main menu.
3.	[↶]	Scroll back one level in the menu.
4.	[▲]	Scroll up one line in the display.
5.	[▼]	Scroll down one line in the display.
6.	[ok]	<ul style="list-style-type: none"> • Open the selected menu. • Confirm a selection.
7.		Red LED lights up to indicate a fault.

Symbols on the display

The display shows different symbols depending on the operating status and operating mode of the EFOY Pro fuel cell:

	Current battery voltage.
	Current charging current of the EFOY Pro fuel cell.
	<p>Fill level of the fuel cartridge.</p> <p> INFO: The fuel gauge for the fuel cartridge is just an indicator and calculates the methanol consumption. The FS1 fuel cartridge sensor must be used to measure the actual fill level. The fuel cartridge should only be replaced once it has been completely emptied.</p>
	A cluster icon is displayed for EFOY Pro devices that run in parallel (see chapter 8.5 "Cluster Controller CC1" on page 91).
	If want to operate the EFOY Pro fuel cell using an external controller, the external control function must be enabled (see chapter 5.4.4 "External control" on page 61). If this is not enabled, a padlock symbol appears (Factory defaults).
	If the external control is switched on, an open padlock appears at the bottom right of the display.
	If you have switched external control on and the device is in "Remote Control" mode, "RC" (Remote Control) appears at the bottom right of the display.
	If the battery type was changed via the expert menu to Lithium iron phosphate (LiFePO ₄), a LiFe-icon appears top right on the display (see chapter 5.1.5 "Expert menu" on page 44).
	The altitude was set above 1,500 meter. An icon appears on the right on the display.

5.1.2 Initial start

Fill in EFOY Initial Start Fluid

Consider filling EFOY Initial Star Fluid into the EFOY Pro 12000 Duo before the initial start. Please follow the descriptions in chapter 4.5 "Fill in EFOY Initial Start Fluid" on page 29.

Switch on

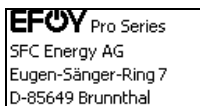

After connecting the EFOY Pro fuel cell to the operating panel for the first time, the intro screen appears on the display.

After a short wait, the language selection appears.

Selecting a language

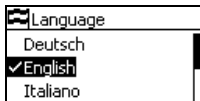

1. Use [▲][▼] to select the required language.
2. Press [ok] to confirm your selection.



Select voltage profile



DANGER!

Danger due to incorrect voltage profile setting.

The selected voltage profile has to confirm to the connected battery voltage.

The responsibility of a proper installation and usage of the application underlie to the user.

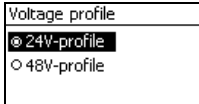

1. Use [▲][▼] to select the voltage profile connected to the EFOY Pro 12000 Duo. Following voltage profiles are available:
 - 24 V profile
 - 48 V profile
2. Press [ok] to confirm your selection.

Select battery type

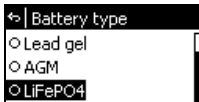
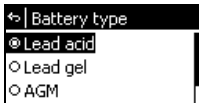

1. Following battery types are available in the "Battery type" menu:
 - Lead-acid
 - Lead Gel
 - AGM
 - LiFePO4 (Lithium iron phosphate)
2. Press [ok] to access to select a battery type. By choosing the LiFePO4 battery type, the Icon "LiFe" will be shown on the Info screen.



CAUTION!

Incorrectly set battery type may damage the battery. This may nullify your warranty.

Only use the precise values permitted for the battery parameters and battery protection settings (see chapter 5.1.5 "Expert menu" on page 44).



INFO:

The factory defaults for all battery types are based on experience and the parameters for the LiFePO4 batteries are tested and approved only with specific batteries. Please refer to your dealer or follow the advice of the battery manufacturer.

Selecting a fuel cartridge

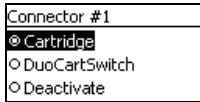

1. Use [▲][▼], to select whether you want to use a single fuel cartridge or a DuoCartSwitch DCS1 for the relevant connector.
2. Press [ok] to confirm your selection.



INFO:

A detailed description of the DuoCartSwitch DCS1 is available in the respective user manual.

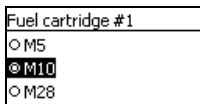

3. Select the relevant fuel cartridge for each connector.
4. Press [ok] to confirm your selection.

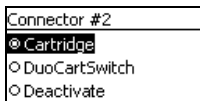



"Connector #1" is displayed first. If you confirm this selection, you can select "Connector #2".

5. Press [ok] to confirm your selection.

5.1.3 Info screen

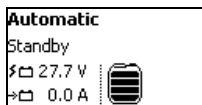
During subsequent operation of the device, an info screen appears after switching the device on:



- Use  to access the operating mode.
- Press [menu] to access the main menu.
- Press [▼] to access the system information.

The first line indicates the operating mode selected, e.g., "Automatic" (see chapter 5.4 "Operating modes" on page 58).

The second line indicates the operating status (see "Operating status" on page 40).

The symbols at the bottom of the display indicate the battery charge condition and the fill level of the fuel cartridge (see "Symbols on the display" on page 36).

Operating mode

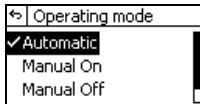

1. Press . The operating mode selection appears.
2. Use [**▲**]/[**▼**] to select the operating mode (see chapter 5.4 „Operating modes“ on page 58).
3. Press [ok] to confirm your operating mode selection.

Operating status

Start phase	The EFOY Pro fuel cell undergoes a start phase lasting up to 20 minutes. At the end of this phase, it has reached its full rated output.
Charging mode	The EFOY Pro fuel cell charges the battery.
Standby	As long as the battery charge has a sufficient degree, the EFOY Pro fuel cell remains in standby mode and monitors the battery.
Shutdown procedure	The EFOY Pro fuel cell shuts down charging mode. To protect the components in the device, this procedure may take several minutes to complete.
Antifreeze	The EFOY Pro fuel cell remains active to protect itself from the effects of freezing. For more information, see chapter 5.5 "Automatic antifreeze mode" on page 63.
Battery protection	The EFOY Pro fuel cell charges the battery automatically in order to prevent deep discharge of the battery.

Interruption	Operation is interrupted because the ambient temperature is too high. The EFOY Pro fuel cell switches on again automatically as soon as operation can be resumed.
Error	An error has been detected, and corresponding messages are displayed. For more information, see chapter 7.2 "Errors and solutions" on page 69.



INFO:

During normal operation, the EFOY Pro 12000 Duo briefly interrupts power generation several times each hour for max. 30 seconds. A charging current of 0.0 A is displayed when this occurs.

The energy gap is reproduced during the charging cycle.

System information

```

*-> | System information
Efoy Pro 12000 Duo
400101-1607-23456
Firmware 19.08
    
```

```

*-> | System information
Charge time
1: 00h 00'  2: 00h 00'
3: 00h 00'
    
```

```

*-> | System information
Operating time: 145h
    
```

1. Press [▼]. The system information is displayed.

The second screen displays information about the duration of charging cycles in different modes.

- 1: Average charge duration in automatic mode.
- 2: Average charge duration in manual mode.
- 3: Average charge duration in remote mode.

The third screen displays operating time and error information. The error messages are explained in chapter 7.2.1 "Error message on the display" on page 69.

Press [↵] to return to the info screen.

5.1.4 Main menu

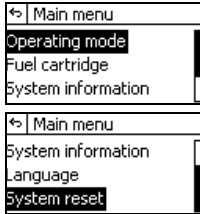

- Press [menu]. The main menu appears.
- Press [▲][▼] to select a submenu.
- Press [ok] to access the selected submenu.
- Press [↵] to return to the info screen.

You can select the following menu options in the main menu:

- Operating mode
- Fuel cartridge
- System information
- Language
- System reset

Operating mode

For a detailed description, see chapter 5.4 "Operating modes" on page 58.

Fuel cartridge

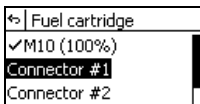

1. Select the connected fuel cartridge.
2. Press [ok] to confirm your selection.



INFO:

If you have not connected a full fuel cartridge, disable the fuel gauge by selecting "Disable fuel gauge" in the menu.

System information

For a detailed description, see "System information" on page 41.

Language

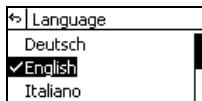

1. Press [▲][▼] to select the language.
2. Press [ok] to confirm the language selection.



Reset

The reset function allows you to restart the EFOY Pro fuel cell:

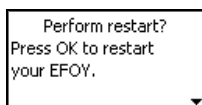

- Mit [ok] bestätigen Sie den Neustart.
- Mit [↶] brechen Sie den Neustart ab und gelangen wieder ins Hauptmenü.

5.1.5 Expert menu



CAUTION!

Incorrectly set operating parameters may damage the device. This may nullify your warranty.

Only use the precise values permitted for the battery parameters and battery protection settings (see page 49).

Before installation and operation please check the battery data sheets from the manufacturers permitted battery values.



- Press and hold [ok] and [menu] at the same time for 2 seconds. The expert menu appears.
- Press [▲][▼] to select a submenu.
- Press [ok] to access the selected submenu.
- Press [↵] to return to the expert menu.

You can select the following menu options in the expert menu:

- Voltage profile
- Battery type
- Battery parameters
- Battery protection
- Communication
- Factory defaults

Voltage profile



1. Press [▲][▼] to select a voltage profile where the EFOY Pro 12000 Duo is connected to. You can select the following voltage profiles:
 - 24 V Profile
 - 48 V Profile
2. Press [ok] to confirm the voltage profile.



DANGER!

Danger due to incorrect voltage profile setting.

The selected voltage profile has to confirm to the connected battery voltage.

The responsibility of a proper installation and usage of the application underlie to the user.

Battery type

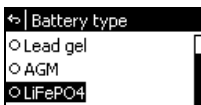
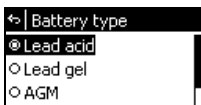

1. You can select the following batteries in the "Battery type" menu:
 - Lead-acid
 - Lead Gel
 - AGM
 - LiFePO4 (Lithium iron phosphate)
2. Press [ok] to access to select a battery type. By choosing the LiFePO4 battery type, the Icon "LiFe" will be shown on the Info screen.



CAUTION!

Incorrectly set battery type may damage the battery. This may nullify your warranty.

Only use the precise values permitted for the battery parameters and battery protection settings on page 49.



INFO:

The factory defaults for all battery types are based on experience and the parameters for the LiFePO4 batteries are tested and approved only with specific batteries. Please refer to your dealer or follow the advice of the battery manufacturer.

Battery parameters

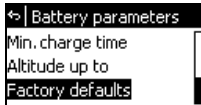
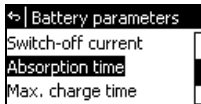
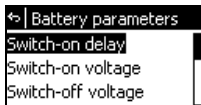

You can select the following options in the "Battery parameters" menu:

- Switch-on delay
- Switch-on voltage
- Switch-off voltage
- Switch-off current
- Absorption time
- Min. charge time
- Max. charge time
- Altitude up to
- Hybrid (only when external control is on)
- Factory defaults



CAUTION!

Incorrectly set operating parameters may damage the device. This may nullify your warranty.

Only use the precise values permitted for the battery parameters and battery protection settings (see page 49).



CAUTION!

Adjust the battery settings according to the application.

Check the battery specific characteristic curve to set the battery parameters fitting to the discharge values.

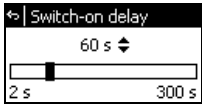
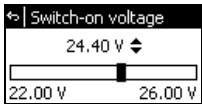
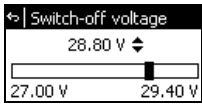
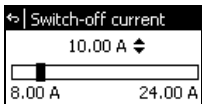
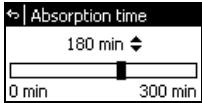
Battery parameters	Function
<p>Switch-on delay</p> 	<p>The EFOY Pro fuel cell does not start immediately if the switch-on voltage only drops below the set threshold level temporarily. The device only starts automatically if the switch-on voltage is still below this threshold level after the switch-on delay of 60 seconds. For example, with the factory default of 24.4 V / 48.8 V for lead-acid batteries, the switch-on voltage must drop below 24.4 V / 48.8 V for at least 60 seconds in order for the EFOY Pro fuel cell to start.</p> <p>If loads with a high rate of power consumption are operated temporarily, this value must be set in accordance with the operating times of these loads.</p>
<p>Switch-on voltage</p> 	<p>The EFOY Pro fuel cell switches on at the set voltage and charges the battery.</p> <p>Setting too high a value for the switch-on voltage results in frequent starting of the EFOY Pro fuel cell. Setting too low a value for the switch-on voltage results in damage to the battery. The default value for lead batteries is 24.4 V / 48.8 V, which corresponds to approx. 50% of the battery charge condition.</p>
<p>Switch-off voltage</p> 	<p>If the battery voltage reaches the set level, the EFOY Pro fuel cell switches off, provided that the value set for the "Switch-off current" or "Absorption time" parameter has also been reached.</p> <p>Please note your battery's end-of-charging voltage. Note the charging recommendations provided by the battery manufacturer.</p>
<p>Switch-off current</p> 	<p>The EFOY Pro fuel cell switches off if the current drops below the set switch-off current.</p> <p>If you want the battery voltage to serve as the only switch-off parameter, set the maximum value, as the current is always below this value in EFOY Pro fuel cells.</p>
<p>Absorption time</p> 	<p>This function serves as an additional switch-off criterion for EFOY Pro fuel cells if the switch-off current level is not reached within the set time period.</p> <p>This period is set by default to 180 minutes, but can be changed to any value between 0 and 300 minutes.</p>

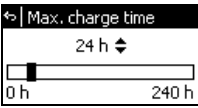
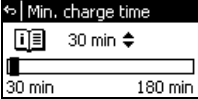
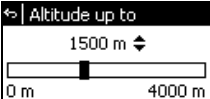
Battery parameters	Function
<p>Max. charge time</p> 	<p>If the switch-off criteria, voltage and current, have not been satisfied, the EFOY unit will shut down after defined operating hours. Once the switch-on criteria have been satisfied, the EFOY unit will turn on again, which can be immediately after the maximum charge time.</p> <p>This switch-off criterion prevents unlimited charge cycles caused by various factors like defective batteries.</p> <p>This criteria can be switched off by setting 0 h.</p>
<p>Min. charge time</p> 	<p>The EFOY Pro fuel cell calculates the average duration of a charging cycle. If this duration drops below the present value of 30 minutes, it indicates the error, too old, defective or battery too small. This can equally be an indication that incorrect battery parameters have been selected. A warning is displayed on the operating panel. Several short charging cycles can damage the EFOY Pro fuel cell and/or the battery. Please contact your local dealer to solve the problem.</p>
<p>Altitude up to</p> 	<p>The EFOY Pro fuel cell is set by default for a use up to an altitude of 3000 meter. For use at a higher altitude for a longer period, we recommend to increase the value.</p>



INFO:

The EFOY Pro fuel cell switches off automatically. In order for the EFOY Pro fuel cell to switch off, the voltage must drop below the set switch-off voltage level, and the current must drop below the set switch-off current. The factory defaults for lead batteries are a switch-off voltage of 28.8 V / 57.6 V and a switch-off current of 10.0 A / 5.0 A. This means that the EFOY Pro fuel cell switches off as soon as the battery reaches a voltage of 28.8 V / 57.6 V and the charging current simultaneously drops below 10.0 A / 5.0 A.

Permitted value ranges for lead batteries (24 V)				
	Factory defaults	Min.	Max.	User-defined value:
Switch-on voltage	24.4 V	22.0 V	26.0 V	
Switch-off voltage	28.8 V	27.0 V	29.4 V	
Switch-off voltage (Hybrid)	29.4 V	27.0 V	30.0 V	
Switch-off current	10 A	8 A	24 A	
Switch-on delay	60 s	2 s	300 s	
Absorption time	180 min	0 min	300 min	
Max. charge time	24 h	0 h	240 h	
Min. charge time	30 min	30 min	180 min	
Altitude up to	1500 m	0 m	4000 m	
Permitted value ranges for lead batteries (48 V)				
	Factory defaults	Min.	Max.	User-defined value:
Switch-on voltage	48.8 V	44.0 V	52.0 V	
Switch-off voltage	57.6 V	54.0 V	58.8 V	
Switch-off voltage (Hybrid)	58.8 V	54.0 V	59.2 V	
Switch-off current	5 A	4 A	12 A	
Switch-on delay	60 s	2 s	300 s	
Absorption time	180 min	0 min	300 min	
Max. charge time	24 h	0 h	240 h	
Min. charge time	30 min	30 min	180 min	
Altitude up to	1500 m	0 m	4000 m	

Permitted value ranges for LiFePO4 batteries (24 V)				
	Factory defaults	Min.	Max.	User-defined value:
Switch-on voltage	25.0 V	24.0 V	26.8 V	
Switch-off voltage	29.0 V	27.6 V	29.2 V	
Switch-off voltage (Hybrid)	29.0 V	27.0 V	30.0 V	
Switch-off current	10 A	8 A	24 A	
Switch-on delay	60 s	2 s	300 s	
Absorption time	180 min	0 min	300 min	
Max. charge time	24 h	0 h	240 h	
Min. charge time	30 min	30 min	180 min	
Altitude up to	1500 m	0 m	4000 m	
Permitted value ranges for LiFePO4 batteries (48 V)				
	Factory defaults	Min.	Max.	User-defined value:
Switch-on voltage	50.0 V	48.0 V	52.0 V	
Switch-off voltage	58.0 V	55.2 V	58.4 V	
Switch-off voltage (Hybrid)	58.0 V	54.0 V	59.2 V	
Switch-off current	5 A	1 A	12 A	
Switch-on delay	60 s	2 s	300 s	
Absorption time	180 min	0 min	300 min	
Max. charge time	24 h	0 h	120 h	
Min. charge time	30 min	30 min	180 min	
Altitude up to	1500 m	0 m	4000 m	

Battery protection



CAUTION!

Incorrectly set operating parameters may damage the device. This may nullify your warranty.

Only use the precise values permitted for the battery parameters and battery protection settings.

The EFOY Pro fuel cell has automatic battery protection when the EFOY Pro fuel cell is switched off.

Battery protection is enabled automatically if the battery voltage (Lead-batteries) drops below 22.0 V / 44.0 V for more than 15 minutes. "Battery protection" mode ends as soon as the voltage reaches 26.4 V / 52.8 V. The switch-off voltage in battery protection mode is not adjustable.

The battery protection function provides deep discharge protection for the battery, even when the EFOY Pro fuel cell is switched off and does not take over the charging function.

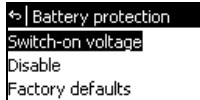

You can select the following menu options in the "Battery protection" menu:

- Switch-on voltage
- Enable/Disable
- Factory defaults

This option allows you to undo all the battery protection settings. Press [ok] to confirm or [↵] to cancel.

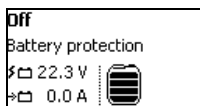

If you want to switch off the EFOY Pro fuel cell after the battery protection function has started, press . The function is re-enabled automatically when the device is switched on or is operated in automatic mode.

	Factory defaults	Min.	Max.	User-defined value:
Permitted value ranges for lead batteries				
Battery protection (24 V)	22.0 V	21.0 V	24.0 V	
Battery protection (48 V)	44.0 V	42.0 V	48.0 V	
Permitted value ranges for LiFePO4 batteries				
Battery protection (24 V)	22.0 V	21.0 V	25.0 V	
Battery protection (48 V)	44.0 V	42.0 V	50.0 V	



INFO:

Please check your system if the fuel cell repeatedly switches back to battery protection. Either the battery has already been damaged or too much energy has been discharged.



INFO:

Battery protection only works if a full EFOY fuel cartridge is connected.

Communication

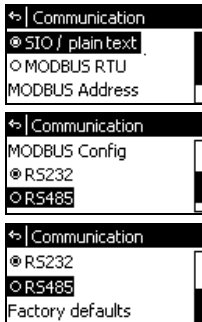

In the menu "Communication" different communication protocols can be selected. Following protocols are adjustable:

- SIO / plain text (Factory setting)
- MODBUS RTU

Two menus are available:

- o MODBUS Address
- o MODBUS Config
- RS232 (Front data interface, factory setting)
- RS485 (Data interface back side, only Modbus RTU)
- Factory defaults

A detailed description is available in this user manual in chapter 8.2 „Communication Protocols“ on page 77.

Factory defaults

This option allows you to undo all the settings made in the expert menu. Press [ok] to confirm or [↵] to cancel.

5.2 Remote control via computer

You can also control the EFOY Pro using a computer. Remote control is also possible using an optional modem.

The same operating functions available via the operating panel are also available via the data interface (see chapter 5.1 "Operation via the operating panel" on page 35).

A detailed description is available in the user manual for the interface adapter IA1.

5.3 Fuel cartridges

5.3.1 Connecting the fuel cartridge

**CAUTION!**

Ensure that a full EFOY fuel cartridge is connected at the initial start of the EFOY Pro fuel cell.

Fuel cartridge empty
Please replace the fuel cartridge, and press OK.

When the fuel cartridge is empty, the yellow LED on the device flashes and the red LED on the operating panel. "Fuel cartridge empty" also appears on the operating panel.

**INFO:**

Check after every connection of a fuel cartridge the functionality at the EFOY Pro fuel cell via manual on.

The fuel cartridge can be changed while the device is in operation.

EFOY fuel cartridges are intended for single use only and cannot be refilled.

**WARNING!**

Use only original EFOY fuel cartridges!

Please refer to the information about methanol provided in chapter 2 "Safety Information" on page 5.



Keep all EFOY Pro fuel cells and EFOY fuel cartridges out of reach of children, even when empty or only partly full.

Connecting the M28 fuel cartridge

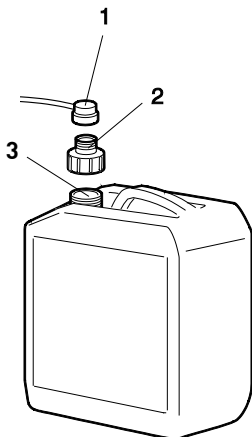

1. Screw the EFOY Pro fuel cartridge connector (1) to the M28 adapter (2).
2. Screw the M28 adapter (2) onto the M28 fuel cartridge (3).
3. Press [ok] on the operating panel so that the red warning light and error message are no longer displayed.

Select the installed fuel cartridge on the operating panel (see chapter 5.3.2 "Selecting a fuel cartridge" on page 56).



INFO:

The M28 fuel cartridge can only be connected using the optional M28 adapter.

For use in vehicles an appropriate fastening has to be used. The installation as well as the safety related inspection has to be done by the user.

The M28 fuel cartridge may also be used on its side in stationary applications. The valve must be on the side at the top for this.

Removing the fuel cartridge

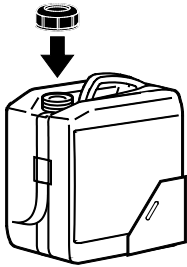

1. Unscrew the fuel cartridge connector from the empty EFOY fuel cartridge.
2. Remove the empty EFOY fuel cartridge.
3. Use the screw cap to seal each EFOY fuel cartridge securely after use.

5.3.2 Selecting a fuel cartridge

When you select the "Fuel cartridge" submenu in the main menu, the display shows the fuel cartridges already enabled and the device connectors.

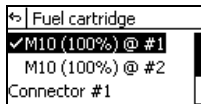

INFO:

If you have not connected a full fuel cartridge, disable the fuel gauge by selecting "Disable fuel gauge" in the menu.

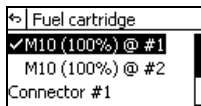
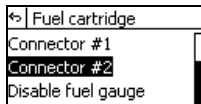

1. Select an active fuel cartridge to edit it directly.
2. Press [ok] to confirm your selection..

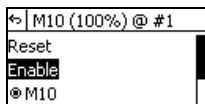

You can select the following actions in the fuel cartridge submenu:

- Reset:
Resets the counter after the fuel cartridge has been changed to 100%.
- Enable:
Enables the fuel cartridge.
- M10 / M28:
Changes the fuel cartridge type for the respective connector.

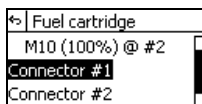

3. Select a connector to edit the connector and any associated fuel cartridges.
4. Press [ok] to confirm your selection.

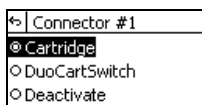

You can select the following actions in the connector submenu:

- Cartridge:
A single fuel cartridge is to be used at the connector. The associated fuel cartridge is displayed at the highest level of the menu.
- DuoCartSwitch:
A DuoCartSwitch is to be used at the connector.
A detailed description of the DuoCartSwitch is available in the respective user manual.
- Deactivate:
Disables the connector.

5.4 Operating modes

The EFOY Pro fuel cell can be operated in one of the following modes:

- Automatic
- Manual On
- Manual Off
- External control on
- Hybrid

5.4.1 Automatic

Automatic mode starts as soon as you connect the device to the battery. The device monitors the battery voltage independently.

The EFOY Pro fuel cell switches on automatically if the battery voltage drops below 24.4 V / 48.8 V (Lead batteries). The battery is then charged until the cut-off threshold of 28.8 V / 57.6 V is reached.

When the device is started, it goes through a start phase, which may last up to 20 minutes. It only reaches its full rated output after this phase.

During normal operation, the EFOY Pro fuel cell briefly interrupts power every 20 minutes for maximal 20 seconds. A charging current of 0.0 A is displayed when this occurs. The lost energy will be generated afterwards.

**INFO:**

If the device fails to start, check that the cap is not still attached to the exhaust hose connector. Remove the cap.

**INFO:**

To ensure optimal battery maintenance, the charging current must not be stopped abruptly when the cut-off threshold is reached. For this reason, the EFOY Pro fuel cell continues charging the battery for up to three hours at a reduced current after the configured cut-off threshold is reached (factory default lead batteries: 28.8 V / 57.6 V). The length of the recharging period depends on the battery voltage and power consumption.

5.4.2 Manual On

You can switch the device on manually if the battery voltage is below 26.4 V / 52.8 V (Lead batteries) or 28.0 V / 56.0 V (LiFePO4). After the start phase, the device is then in "charging mode".

The device operates independently of the configured switch-on voltage, and charges the battery until the cut-off threshold is reached.

($U_{\text{batt}} > 28.8 \text{ V} / 57.6 \text{ V}$ and $I_{\text{off}} < 10.0 \text{ A} / 5.0 \text{ A}$)

Please note: The EFOY Pro fuel cell can only start if it is connected to an intact battery and a filled fuel cartridge. The EFOY Pro fuel cell does not switch on if the battery is damaged or has been deeply discharged.

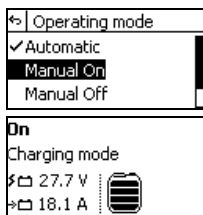

1. Press  on the operating panel, or select "Operating mode" in the main menu. The operating mode selection appears.
2. Select the "Manual On" operating mode.
3. Press [ok] to confirm your selection.

5.4.3 Manual Off



INFO:

To protect the components, the device should not be switched off until it has been running for at least 30 minutes since it was started. If the device is switched off before this period has elapsed, it will continue running for the remainder of the required running time. The message "Shutdown procedure" is shown on the display. Do not disconnect the fuel cartridge or battery during the shutdown procedure.



INFO:

The battery protection and automatic antifreeze functions remain active after the device is switched off.

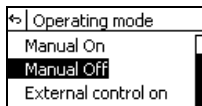

1. Press  on the operating panel, or select "Operating mode" in the main menu. The operating mode selection appears.
2. Select the "Manual Off" operating mode.
3. Press [ok] to confirm your selection.

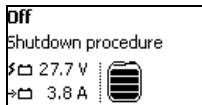

4. Wait until the shutdown procedure has finished and "Shutdown procedure" is no longer displayed on the info screen.



INFO:

Do not disconnect the fuel cartridge or battery during the shutdown procedure.

The shutdown procedure may take some time, to ensure that all protective features are applied.

5.4.4 External control

You can control the EFOY Pro externally using a switching contact, e.g. a solar charger. To do this, the "External control" operating mode must be enabled.

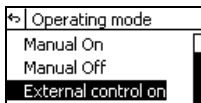

1. Press on the operating panel, or select "Operating mode" in the main menu. The operating mode selection appears.
2. Select the "External control on" operating mode.
3. Press [ok] to confirm your selection.

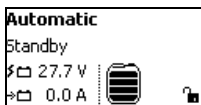

An open padlock is displayed at the bottom right of the display.

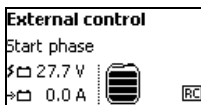

If the controller now receives an external signal, "RC" (Remote Control) is displayed at the bottom right of the display.

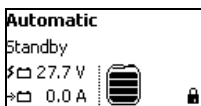

INFO:

If you have not enabled external control, a closed padlock is displayed at the bottom right of the display when an external signal is being received.

The unit starts disregarding the switch-on voltage and charges the batteries until the set switch-off parameters.

5.4.5 Hybrid



CAUTION!

Incorrectly set operating parameters may damage the device. This may nullify your warranty.

Only use the precise values permitted for the battery parameters and battery protection settings.

The EFOY Pro can be set into Hybrid mode by a voltage signal or a software control. In this operation mode all parameters are disabled, like switch-on voltage or battery protection. Only the frost protection mode is an exception.

Activation via voltage signal:

Connect Pin 4 (GND, Ground) or the negative battery pol with Pin 8 (Hybrid)

Activation via software control:

Send at least every 15 seconds the SIO command HYBRID or Modbus address 42002 Hybrid to the EFOY Pro fuel cell.

To start the EFOY Pro fuel cell a positive voltage signal must be connected to Pin 7 (Remote On) or via software SIO command REMOTE or Modbus address 41030.

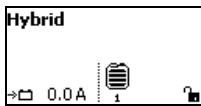

INFO:

The battery voltage is deactivated in hybrid mode and is not shown on the display.

The max. set value switch-off voltage (Hybrid) will not be exceeded. If the voltage signal on pin 7 or the software commands are not removed the EFOY Pro fuel cell will charge the battery continuous in full and part load mode.

5.5 Automatic antifreeze mode

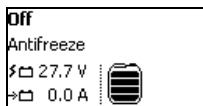

The device has an intelligent automatic antifreeze feature. This operating status switches on automatically as soon as the temperature drops below +3 °C / +37.4 °F. This prevents the device from freezing. If the device is operating in antifreeze mode, the message "Antifreeze" is shown in the second line of the display.



CAUTION!

The automatic antifreeze feature only works when the fuel cell is connected to a filled EFOY fuel cartridge and an intact battery.



INFO:

The battery protection as well as the antifreeze mode is also active when the EFOY Pro 12000 Duo is in switch off mode.



INFO:

The methanol consumption in the antifreeze mode depends on the climatic conditions.

5.6 Shutdown

5.6.1 Switching off the fuel cell

Switch off the EFOY Pro fuel cell via the operating panel or directly on the device. This is described in chapter 5.4.3 "Manual Off" on page 60.

5.6.2 Removing the EFOY fuel cartridge

This is described in "Removing the fuel cartridge" on page 56.



INFO:

Protect the fuel cartridge and the fuel cartridge connector on the device from impurities.

5.6.3 Secure transportation and storage procedure

For a secure transport and storage the secure transport and storage procedure has to be executed, especially when the EFOY Pro 12000 Duo fuel cell is exposed temperatures below +1 °C / +34 °F.

The following items are required for this procedure:

- Resealable canister (2 liter)
- Isolated hexagon socket screw key (Allen key)
- Methanol-resistant gloves
- Safety goggles

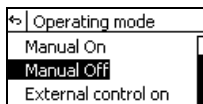

Follow the instructions shown on the display:

1. Shut down EFOY Pro 12000 Duo via "Manual Off" and let the unit cool down.
2. Press [menu] and [▼] for at least 3 seconds.
3. Put the resealable 2 liter canister under the opening screw on the bottom and unscrew the outlet screw.

Transport lock
Your EFOY is now
ready for shipment or
storage.

4. This procedure can take at least up to 5 minutes. After completing the procedure a message will be shown in the display.
5. Rescrew in the outlet screw.

5.6.4 Detaching the charge line and data line

1. Switch off the voltage connection between EFOY Pro 12000 Duo and the battery via the switch off switch.
2. Disconnect the electrical connection afterwards.



INFO:

Store the plugs and cables in a cool, dry place.

5.6.5 Detaching the exhaust hose

Disconnect the exhaust hose. Protect it from impurities and seal the exhaust outlet with the protective cap.



CAUTION!

Store the EFOY Pro fuel cell in a cool place, but at a temperature over +1 °C / +34 °F. (See also storage temperature in chapter 3.3 "Specifications" on page 18).

If the EFOY Pro fuel cell is exposed to temperatures below +1 °C / +34 °F without connected batteries and sufficiently filled fuel cartridges, it must be defrosted for approximately 24 hours at room temperature before use.



INFO:

Use a suitable box for storing the EFOY Pro fuel cell, e.g., the box in which it was delivered. The EFOY Pro fuel cell must be stored in an upright position only.

6 Maintenance

6.1 Service

Under normal operating conditions, the EFOY Pro fuel cell is maintenance-free.

**WARNING!**

Do not open the EFOY Pro fuel cell! Unauthorized opening of the EFOY Pro fuel cell interferes with safe operation of the device and nullifies the warranty and guarantee. The EFOY Pro fuel cell does not contain any parts that you can maintain or repair yourself.

**CAUTION!**

Burn Hazard.

Hot surfaces. In operation temperature up to +65 °C / +150 °F at heat exchanger possible. Do not touch.

6.2 Long term storage

**CAUTION!**

Store the EFOY Pro fuel cell in a cool place, but at a temperature over +1 °C / +34 °F. (See also storage temperature in chapter 3.3 "Specifications" on page 18).

If the EFOY Pro fuel cell is exposed to temperatures below 0 °C / 32 °F without connected batteries and sufficiently filled fuel cartridges, it must be defrosted for approximately 24 hours at room temperature before use.

After long term storage over 6 month SFC recommends to check the functionality of the EFOY Pro fuel cell before installation. For that purpose connect the fuel cell to a battery to run a charging cycle. A charging cycle can last several hours. After successfully passing the charging cycle run the transport lock procedure. Press the [menu] and [▼] button on the Operating panel at least 3 seconds and follow the instructions on the display.

**CAUTION!**

Note that liquid can drop out when running the transport lock procedure.

**INFO:**

Use a suitable box for storing the EFOY Pro fuel cell, e.g., the box in which it was delivered. The EFOY Pro fuel cell must be stored in an upright position only.

6.3 Firmware update

Be sure to check on a regular basis which updates are available for your firmware.

Simply connect the EFOY Updater to your EFOY Pro fuel cell data interface at the front side to perform the update.

**INFO:**

For an update with the EFOY Updater the RS232 data interface has to be activated. If RS485 is in use change the communication interface to RS232.

For information on the latest firmware updates and the Updater, please contact your service partner or go to www.efoy-pro.com.

6.4 Cleaning

**WARNING!**

Switch the device off and disconnect the charge line before cleaning.

The device is not water-tight. Please ensure that no moisture can enter the device.

1. Clean only with a soft cloth dampened with a mild detergent.
2. Reconnect the battery charge line after cleaning so that the automatic antifreeze feature remains activated (see chapter 5.5 “Automatic antifreeze mode” on page 63).

7 Troubleshooting

7.1 Safety

**WARNING!**

Do not open the EFOY Pro fuel cell! Unauthorized opening of the EFOY Pro fuel cell interferes with safe operation of the device and nullifies the warranty and guarantee. The EFOY Pro fuel cell does not contain any parts that you can maintain or repair yourself.

If you cannot resolve an error using these instructions, please contact the sales partner from whom you purchased the device, or contact our service hotline directly.

Contact details

Headquarters

SFC Energy AG

Eugen-Saenger-Ring 7

85649 Brunnthal

Germany

Hotline: +49 89 / 673 592 555

Freecall: 00800 / 732 762 78*

eMail: service@sfc.com

Web: www.efoy-pro.com

*Calls can be placed free of charge from the landline from: Germany, Belgium, Denmark, France, Great Britain, Italy, the Netherlands, Norway, Austria, Sweden, Switzerland and Spain.

7.2 Errors and solutions

7.2.1 Error message on the display

In the event of interruptions and errors, the operating panel displays warning messages on the display panel, including an error code and instructions on how to resolve the error.

By following these instructions, you can quickly and easily eliminate some of the errors that may occur.

Error message on the display	Error code	Solution
Service is required. Protect device against frost! Please contact EFOY hotline or hotline@sfc.com .	1 10 15 31 76 83	Please contact your service partner or the hotline. Contact details are provided in chapter 1.2 "Contact details" on page 4.
A restart is required. If the error occurs again please contact EFOY hotline or hotline@sfc.com . Press OK for restart.	13 14 17 70 73 75 80 81 84	Select the "System reset" option in the main menu to restart the device (max. twice). If the error still occurs, please contact your service partner or the hotline. Contact details are provided in chapter 1.2 "Contact details" on page 4.
Please make sure the exhaust hose is not blogged, bent or frozen. Press OK for restart.	11 18	Please check the installation of the exhaust hose and position it so that no condensation can gather. Do not bend the exhaust hose. If necessary, clean the exhaust hose and protect the opening from becoming clogged. Shorten the exhaust hose if condensation is gathering in it.

Error message on the display	Error code	Solution
Fuel cartridge empty. Please replace the fuel cartridge, and press OK.	20 22	See chapter 5.3.1 "Connecting the fuel cartridge" on page 54.
Please refill service fluid Press OK for restart.	30	Make sure that the off-heat can escape without obstruction and that the ambient temperature is below +50 °C / +122 °F. If the fuel cell is installed within a sealed container, please ensure that the opening for supply air has a cross-section of at least 10 cm / 3.94 in. Then refill the fuel cell with EFOY service fluid (see chapter 7.3 "Adding EFOY recovery fluid" on page 73).
Interruption: Cooling insufficient. Please check installation and air supply!	32	The cooling air is insufficient or the ambient air is too warm. Please check whether the room in which the fuel cell is installed has sufficient ventilation, or whether the openings for the air supply in the EFOY Pro fuel cell are blocked.
Interruption: Device frozen. Please defrost device slowly for at least 24h at room temperature.	40	The device was exposed to temperatures below +1°C / +34°F without a connected battery and/or an EFOY fuel cartridge that was not filled sufficiently. It must be allowed to defrost for approx. 24 hours at room temperature.
Interruption: Surroundings too warm. Please wait for the device to cool down.	41	The ambient temperature is too high. The device will start automatically if the temperature drops to below +40 °C / +104 °F.

Error message on the display	Error code	Solution
Battery voltage low. Please check battery connection and load battery.	50 52	Please check the cabling and check whether a suitable battery is connected. Check the battery voltage. If it is too low, please load the battery with a battery charger. Please also check other loading devices for defects, e.g. alternator or charge controller.
Battery voltage high. If applicable, please check additional charging devices.	51 53	Please check the cabling and check whether a suitable battery is connected. Please also check other loading devices for defects, e.g. alternator or charge controller.
Please disconnect fuel cartridge connection, shake cartridge firmly and reconnect. Restart device at most 2 times. Press OK for restart.	72	Check the fuel cartridge connection and, if necessary, check for any contamination and remove it. Then please perform a system reset (max. twice). If the error still occurs, please contact your service partner or the hotline. Contact details are provided in chapter 1.2 "Contact details" on page 4.

7.2.2 Display Warnings

Error message on the display	Solution
Interruption: Cooling insufficient. Please check installation and air supply!	The cooling air is insufficient or the ambient air is too warm. Please check whether the room in which the fuel cell is installed has sufficient ventilation, or whether the openings for the air supply in the EFOY Pro fuel cell are blocked.

<p>Battery defective, too small or too old. Please check the battery and contact EFOY-Hotline or service@sfc.com</p>	<p>The on-board electrical system including the battery has to be checked. The EFOY Pro has measured charging cycles which were too short. This is an indication of a defective, too old or too small battery. The battery parameters may also need to be reviewed.</p>
<p>Note: Supply problem at fuel connector #1.1 #1.2 #2.1 #2.2. Please check fuel connector. If this problem occurs again please contact your service partner.</p>	<p>Check the fuel cartridge connector for contamination and proper fuel cartridge connection. Check the fuel cartridge on functionality and exchange it if necessary. The connector can be reset in the cartridge menu in the operation panel.</p>

7.2.3 Errors without display messages

Possible cause	Solution
<p>No battery is connected, the battery has not been properly connected, or a deep discharge has occurred.</p>	<p>Check the pins, polarity and cables (see chapter 4.6 "Electrical connection" 31). Connect a charged battery in order to start the device.</p>
<p>Short-circuit has occurred.</p>	<p>Ensure that the polarity of the charge line is correct. Switch off the device, check the cause of the short circuit or overload, and eliminate the error.</p>

If the problem recurs:

Please contact your service partner or the hotline.

Freecall:
00800 / 732 762 78*

Hotline:
+49 89 / 673 592 555

service@sfc.com

www.efoy-pro.com

*Calls can be placed free of charge from the landline from: Germany, Belgium, Denmark, France, Great Britain, Italy, the Netherlands, Norway, Austria, Sweden, Switzerland and Spain.

7.3 Adding EFOY recovery fluid

Error 30
Please refill recovery fluid. To restart press OK.

If the internal EFOY fluid level is low, the red LED on the EFOY Pro fuel cell comes on and the message "Please refill recovery fluid" appears on the operating panel display.



WARNING!

If this message is displayed frequently, check that the air supply at the installation location is sufficient. There is no need to add EFOY recovery fluid under normal operating conditions.

Never refill the fuel cell with more than one bottle of EFOY recovery fluid at a time.

Use original EFOY recovery fluid only.

Switch off the EFOY Pro fuel cell before refilling with EFOY recovery fluid. Disconnect the charge line.

Make sure that no dirt or foreign bodies enter the fill opening.

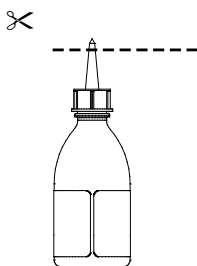

1. Use a clean pair of scissors to cut off the tip of the bottle.



INFO :

The EFOY recovery fluid bottle is for one time use only.



2. Unscrew the opening screw for EFOY fluids (EFOY fluids only) with 6 mm allen key. Keep the screw close for further use.
3. Insert the tip of the bottle into the connection nozzle on the device and slowly squeeze the entire contents slowly into the opening.



4. Use a cloth to wipe away any excess EFOY service fluid that may spill over.
5. Bolt the opening screw again.
6. When you have finished filling the device, press [ok]. The message is deleted and the EFOY Pro fuel cell returns to its previous operating status, e.g. automatic mode.
7. Be sure to order your next refill of EFOY recovery fluid from your specialist dealer in plenty of time.

8 Data Interface and Optional Accessories

8.1 Data interface functionality

The EFOY Pro data interface enables the connection of:

- Computer or modem with the interface adapter IA1
- Fuel cartridge sensor FS1
- Cluster controller CC1
- DuoCartSwitch DCS1



CAUTION!

The data interface cannot be connected directly to a computer. The interface adapter is required for this.

Connecting the EFOY Pro fuel cell directly to a computer can damage both devices.

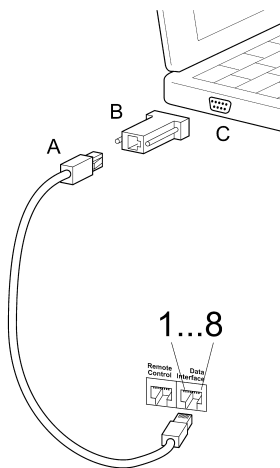

- A. CAT5 data line
- B. Interface Adapter IA1
- C. PC (COM interface)

Pin	Data Interface
1	DuoCartSwitch DCS1
2	RS232 TxD (Transmit Data)
3	RS232 RxD (Receive Data)
4	GND, Ground
5	Battery +
6	Fuel Cartridge Sensor FS1
7	Remote On
8	Parallel/hybrid operation control

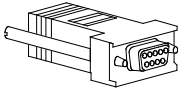

The interface adapter IA1 is used to connect the EFOY Pro to a computer or modem via the COM connection.

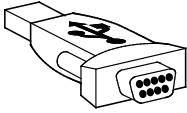

The USB adapter enables you to connect the interface adapter to the USB connection if no COM connection is available.

8.2 Communication Protocols

The communication with the EFOY Pro fuel cells is possible via RS232 and RS485 data connection. Also a direct modem connection for external control and observation is possible.

Following protocols are supported:

- SIO / clear text (RS232, factory settings)
- MODBUS RTU (RS232 and RS485)

The settings can be changed via the Operating panel OP2:

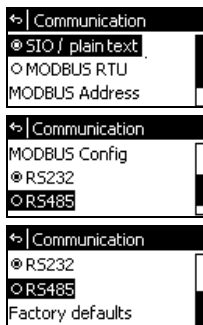

1. Press and hold [ok] and [menu] at the same time for 2 seconds. The expert menu appears.
2. Press [▼] to select a submenu “Communication” and press [ok] to access.
3. Press [▲][▼] to select one of the following communication protocols:
 - o SIO / plain text
 - o MODBUS RTU
4. Select the required communication protocol for the RS232 interface and press [ok] to select.

Data interfaces

If MODBUS RTU protocol should be used you have to choose which interface side is in use. You have to activate the interface on the front and back side in the menu “Communication”:

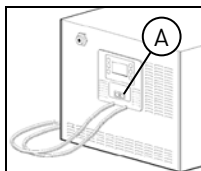

A. Data interface front side

Data interface: RS232

The description for the data interface can be found in chapter 3.2 “Connections” on page 15.

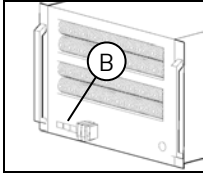
**B. Data interface back side**

Data interface: RS485

The description for the data interface can be found in chapter 3.2 “Connections” on page 15.

1. Press and hold [ok] and [menu] at the same time for 2 seconds. The expert menu appears.
2. Press [▼] to select a submenu “Communication” and press [ok] to access.
 - RS232 (Data interface front side, factory settings)
 - RS485 (Data interface back side)
3. Select the required data interface and press [ok] to select.

**INFO :**

Only the activated interface is ready for use. The deactivated interface is without function

8.2.1 Modbus RTU

The EFOY Pro fuel cell enables a MODBUS RTU communication via the RS-232 or RS485 data interface.

Following parameters are set for the MODBUS RTU protocol:

Baud rate: 9600

Data bits: 8

Parity: Even Parity

Stop bits: 1

Display in Operating panel OP2: 9600 8,E,1

The parameters can be changed on demand via Operating panel OP2, PC or Laptop.

Via Operating panel OP2:

1. Press and hold [ok] and [menu] at the same time for 2 seconds. The expert menu appears.
2. Press [▼] to select a submenu “Communication” and press [ok] to access.
3. Select a submenu “MODBUS Config” and press [ok].
4. Press [▲][▼] to select one of the following MODBUS configurations. Press [ok] to confirm.

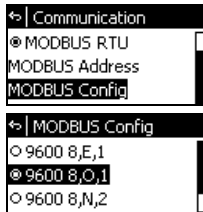

Following configurations are available:

Display in Operating panel OP2	9600 8,E,1 (Standard)	9600 8,O,1	9600 8,N, 2	9600 8,N,1
Baud rate	9600	9600	9600	9600
Data bits	8	8	8	8
Parity	Even Parity	Odd Parity	No Parity	No Parity
Stop bits	1	1	2	1

Via PC or Laptop:

With the SIO command “MODBUS” the configurations can be adjusted as well as the MODBUS RTU protocol can be activated.

A detailed description is available in the user manual for the interface adapter.

Connection to a RS485 network

An RS485 interface is provided at the data interface back side of the EFOY Pro 12000 Duo.



INFO:

The pre-installed MODBUS Address is the last 2 numbers of the serial number. The EFOY Pro with serial number 123456-1234-56789 has the address 89. In the case where the serial number ends with 00 the address 100 is set.

The MODBUS address of each EFOY Pro fuel cell can be changed via the Operating panel or with the MODBUS command:



CAUTION!

Wrong set addresses can cause conflicts within the communication network!

Make sure that every MODBUS address in an RS-485 network is only given once. If one address is given to several components the network can be disturbed.

The description for the data interface can be found in chapter 3.2 “Connections” on page 15.

Via operating panel:

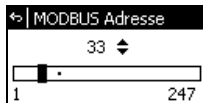

1. Press and hold [ok] and [menu] at the same time for 2 seconds. The expert menu appears.
2. Press [▼] to select a submenu “Communication” and press [ok] to access.
3. Select a submenu “MODBUS Address” and press [ok].
4. Press [▲][▼] to select a MODBUS address between 1 and 247. Press [ok] to confirm.



INFO:

If the EFOY Pro fuel cell is disconnected from the battery the changed MODBUS address will be saved.

Check and adjust the MODBUS address when connecting the EFOY Pro fuel cell to a new network.

Via PC or Laptop:

With the SIO command “MODBUS” the configurations can be adjusted as well as the MODBUS RTU protocol can be activated.

A detailed description is available in the user manual for the interface adapter.

8.2.1.1 MODBUS RTU functions

The EFOY Pro MODBUS protocol is based on following Modbus specifications:

Modbus application protocol V1.1b3

Specific feature: Type RTC (Real Time Clock)

Use following bit field definition for decoding RTC types (e.g. system time and date):

```
struct {
    unsigned long second : 6; // seconds 0 to 59
    unsigned long minute : 6; // minutes 0 to 59
    unsigned long month : 4; // month 1 to 12
    unsigned long hour : 5; // hour 0 to 23
    unsigned long day : 5; // day 1 to 31
    unsigned long year : 6; // year - 2000 (max. 63)
};
```

Read Device Identification (Function code 0x2B)

Read out system information

Object ID	Name	Example	Type
0x00	VendorName	SFC Energy AG	STRING
0x01	ProductCode	400100-1525-00001	STRING
0x02	MajorMinorRevision	19.08	STRING
0x03	VendorUrl	http://www.sfc.com/	STRING
0x04	ProductName	EFOY Pro Series	STRING
0x06	UserApplicationName	Firmware EFOY Pro 12000 Duo V01 19.08I24V/48V QB date 2016-03-24	STRING

Read only (Function code 0x03)

Registers only for reading.

Address	Name	Description	Unit	Multiplier	Type
700	MeOH	Methanol consumption	l	0,000001	UINT32
702	OnReason	Last switch on reason	-	1	UINT8
703	OffReason	Last switch off reason	-	1	UINT16
704	LoadDrops	Number of load disconnections	-	1	UINT8

Address	Name	Description	Unit	Multiplier	Type
705	AvgCycle Auto	Average charging duration in automatic mode	-	1	FLOAT
707	AvgCycle Manual	Average charging duration in manual mode	h	1	FLOAT
709	AvgCycle Remote	Average charging duration in remote mode	h	1	FLOAT
711	LastCycle Auto	Last charging duration in automatic mode	h	1	FLOAT
713	LastCycle Manual	Last charging duration in manual mode	h	1	FLOAT
715	LastCycle Remote	Last charging duration in remote mode	h	1	FLOAT
717	LastRun	Date of last stack run	-	1	RTC
800	Rev	Firmware version	-	1	UINT32
30001	Tst	Stack temperature	°C	0.001	INT32
30005	Twt	Heat exchanger temperature	°C	0.001	INT32
30007	Tdcdc	Periphery temperature	°C	0.001	INT32
30009	Tpcb	Periphery temperature	°C	0.001	INT32
30011	Tres	Periphery temperature	°C	0.001	INT32
30015	Ubat	Battery voltage	V	0.001	UINT16
30016	Uaus	Output voltage	V	0.001	UINT16
30017	Uklemm	Internal voltage	V	0.001	UINT16
30018	Uper	Internal voltage	V	0.001	UINT16
30020	Ust	Stack voltage	V	0.001	UINT16
30021	Uzell	Internal voltage	mV	0.1	UINT32
30023	ULF1	Internal voltage	V	0.001	UINT16
30024	Uref	Internal voltage	V	0.001	UINT16
30028	laus	Output current	A	0.001	INT16
30029	lper	Periphery current	A	0.001	UINT16
30030	lst	Stack current	A	0.001	UINT16
30031	Pst	Stack power	W	0.001	UINT32
30033	Pper	Internal power	W	0.001	INT32
30035	FuellSt	Internal filling	%	0.01	UINT16
30036	LastError	Last occurred error	-	1	UINT8
30037	Error	Current error	-	1	UINT8
30038	StBtrb	Operating hours stack	h	0,001	UINT32
30040	SysBtrb	Operating hours system	h	0,001	UINT32
30042	PcStack	Internal value	-	1	UINT8

Address	Name	Description	Unit	Multiplier	Type
30043	PcAux	Internal value	-	1	INT32
30045	ResF	Internal value	-	1	UINT16
30046	DHV	Internal value	-	1	FLOAT
30048	DC-DC	Internal value	%	0.01	INT16
30049	AdW	Internal value	-	1	UINT8
30050	FS	Fuel cartridge sensor FS1 status	-	1	UINT8
30051	SysTime	System time	h	1	RTC

Write only (Function code 0x10)

Registers only for writing.

Address	Name	Description	Value	Type
41016	Cartridge Reset	Reset fuel gauge of cartridge port to 100 %. C: Connector DCS1: DuoCartSwitch DCS1	1: C#1 11: C#1 DCS1#1 12: C#1 DCS1#2 2: C#2 21: C#2 DCS1#1 22: C#2 DCS1#2 -1 : All	INT16
41996	Modbus Address	Set Modbus address	1 - 247	INT16
41998	Modbus Config	Set Modbus communication settings.	0: 9600 8,E,1 1: 9600 8,0,1 2: 9600 8,N,2 3: 9600 8,N,1	INT16
42000	Reset	Restart the fuel cell.	-	INT16
42002	Factory Defaults	Set all parameters to default.	-	INT16
42004	Hybrid	Deactivate all parameters for 15 seconds.	-	INT16
42006	Plain text Protocol	Switch device to plain text interface.	-	INT16
42008	Level converter select	Set data interface: Front side RS232, back side RS385	0: RS232 1: RS485	INT16
49999	IDSTATESEL	Select expert setting read property of selected ID. See chapter 8.2.1.2 "Overview ID list" on page 86.	0: Actual value 1: Standard value 2: Min. value 3: Max. value	INT16

Read/Write registers

Register for reading and writing.

Address	Name	Description	Value	Type
40990	IDSELECT	Select expert setting ID.	See chapter 8.2.1.2 "Overview ID list" on page 86.	UINT16
40991	IDVALUE	Read/write expert setting of selected ID.	See chapter 8.2.1.2 "Overview ID list" on page 86.	INT32
41000	Button	Change operation mode.	0: OFF 1: ON 2: AUTO	UINT16
41002	Cartridge Port 1	Configuration of cartridge port #1.	-1: DCS 0: disabled 1: M10 2: M28	INT16
41004	Cartridge Port 11	Configuration of cartridge port #1.1.	1: M10 2: M28	INT16
41006	Cartridge Port 12	Configuration of cartridge port #1.2.	1: M10 2: M28	INT16
41008	Cartridge Port 2	Configuration of cartridge port #2.	-1: DCS 0: disabled 1: M10 2: M28	INT16
41010	Cartridge Port 21	Configuration of cartridge port #2.1.	1: M10 2: M28	INT16
41012	Cartridge Port 22	Configuration of cartridge port #2.2.	1: M10 2: M28	INT16
41014	Cartridge Select	Activate cartridge port. C: Connector DCS1: DuoCartSwitch DCS1	1: C#1 11: C#1 DCS1#1 12: C#1 DCS1#2 2: C#2 21: C#2 DCS1#1 22: C#2 DCS1#2	INT16
41020	Battery Type	Set battery type.	0: lead acid 1: lead gel 2: AGM 3: LiFePO4	INT16

Address	Name	Description	Value	Type
41022	External Control	Software lock for external control.	0: On 1: Off	INT16
41024	Battery Protect	Battery protection mode.	0: On 1: Off	INT16
41026	Fuel gauge Display	Fuel gauge state on Operating panel OP1.	0: Off 1: On	INT16
41028	Language	Adjust language on Operating panel OP1.	0: German 1: English 2: Italian 3: Spanish 4: French 5: Dutch	INT16
41030	External Remote	External software remote signal.	0: Off 1: On	INT16
41032	Voltage profile	Set voltage profile	0: 24V Profil 1: 48V Profil	INT16

8.2.1.2 Overview ID list

Profile	Type	ID	Name	Standard	Min.	Max.
All	All	45	Reaction time	60 s	2 s	300 s
		17	Altitude of site up to	1500 m	0 m	4000 m
		24	Absorption time	180 min	0 min	300 min
		89	Minimum charging time	30 min	30 min	180 min
	Lead	49	Max. output time	24 h	2 h	240 h
	LiFePO4	77	Max. output time	48 h	2 h	240 h
24 V	Lead	21	Switch-on voltage	24400 mV	22000 mV	26000 mV
		22	Switch-off voltage	29000 mV	27600 mV	29200 mV
		23	Switch-off current	10000 mA	8000 mA	24000 mA
		47	Battery protection switch-on voltage	22000 mV	21000 mV	24000 mV
		75	Switch-off voltage hybrid	29000 mV	27000 mV	30000 mV
	LiFePO4	78	Switch-on voltage	25000 mV	24000 mV	26000 mV
		79	Switch-off voltage	29000 mV	27600 mV	29200 mV
		80	Switch-off current	10000 mA	8000 mA	24000 mA
		81	Battery protection switch-on voltage	22000 mV	21000 mV	24000 mV
		82	Switch-off voltage hybrid	29000 mV	27000 mV	30000 mV
48 V	Lead	33	Switch-on voltage	48800 mV	44000 mV	52000 mV
		34	Switch-off voltage	57600 mV	54000 mV	58800 mV
		35	Switch-off current	5000 mA	4000 mA	12000 mA
		36	Battery protection switch-on voltage	44000 mV	42000 mV	48000 mV
		37	Switch-off voltage hybrid	58000 mV	54000 mV	59200 mV
	LiFePO4	38	Switch-on voltage	50000 mV	48000 mV	52000 mV
		39	Switch-off voltage	58000 mV	55200 mV	58400 mV
		40	Switch-off current	5000 mA	4000 mA	12000 mA
		41	Battery protection switch-on voltage	44000 mV	42000 mV	48000 mV
		42	Switch-off voltage hybrid	58000 mV	54000 mV	59200 mV

Recommended way to read expert setting parameter:

1. Write (command 0x10) desired expert setting ID to MODBUS Register 40990 (IDSELECT)
2. Use a combined read & write (command 0x17), write setting property to read to 49999 (IDSTATESEL) and read 40991 (IDVALUE).

Recommended way to write expert setting parameter:

1. Write (0x10) desired expert setting ID to MODBUS register 40990 (IDSELECT)
2. Write desired value to 40991 (IDVALUE) using command.

8.2.2 SIO / Plain text

Following commands are available in the clear text protocol:

Command	Description
?	Display command overview.
BATTERY	Select battery type
BATTERYPROTECTION	Control battery protection
BUTTON	Software control of device
CARTRIDGE	Set/view connected fuel cartridges/DuoCartSwitch
CONFIG	Set customized operation parameters
DEFAULT	Apply default operation parameters
ERROR	Show ten most recent errors
FUELGAUGE	Enable/disable fuel gauge
GET	Get customized operation parameter
HYBRID	Switch the device from automatic into hybrid mode for 15s
LANGUAGE	Set language in Operating panel OP2
LIMITS	Show min. and max. values of operation parameters
LOCKED	Lock control contacts
LOG	Show details of current operation state
MODBUS	Settings of MODBUS protocol
PROFILE	Select voltage profile
REMOTE	Remote control via software interface
RESET	Restart the device
SERIAL	Show the device's serial numbers
SET	Set customized operation parameter
SFC	Show current operation state
STDVALUE	Show default values of operation parameters
SYSTEM	Reason for last start-up and stop
VALUE	Show current values of operation parameters
VER	Show version of firmware

A detailed description is available in the user manual for the interface adapter IA1.

8.3 GSM-Modem

The optional GSM modem enables you to monitor and control the EFOY Pro fuel cell remotely. It is recommended to use such a solution for autonomous operation of the EFOY Pro.

Functions

- Notification if errors occur
- Notification if fuel cartridge falls below the reserve (with optional fuel cartridge sensor FS1)
- Remote diagnostics
- Remote control
- Remote parameter adjustment
- Firmware update via GSM modem

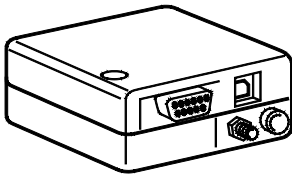

A detailed description is available in the user manual.

8.4 Fuel cartridge sensor FS1

By default, the EFOY Pro does not monitor the actual fill level of the fuel cartridge. The fuel gauge for the fuel cartridge is just an indicator and calculates the methanol consumption. The FS1 fuel cartridge sensor must be used to measure the actual fill level. The EFOY Pro reports a fuel level error if the cartridge is used up.

The optional fuel cartridge sensor FS1 indicates if the fuel level drops below the position of the sensor. This early warning gives the user time to change the cartridge before it is completely empty.

The fuel cartridge sensor FS1 may also be used with fuel cartridges that are partly empty. It sends a signal to the EFOY Pro fuel cell when the fill level falls below the sensor.

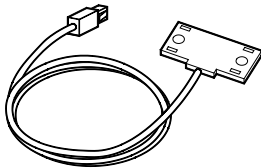

You connect the sensor to the EFOY Pro data interface.

The sensor should be combined with a remote monitoring system, e.g. the GSM modem GSM-2-SMS.

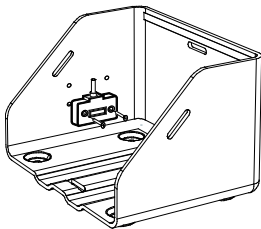

You fasten the fuel cartridge sensor to the fuel cartridge holder for M10 fuel cartridges using two screws. You can choose from two different heights to mount the FS1.

A detailed description is available in the user manual "Fuel cartridge sensor FS1".

8.5 Cluster Controller CC1

The cluster controller combines 3 functions:

1. Interface splitter (provides 2 sockets)
2. Parallel operation of up to 5 EFOY Pros
3. Remote control of one EFOY Pro (Remote-on pin)

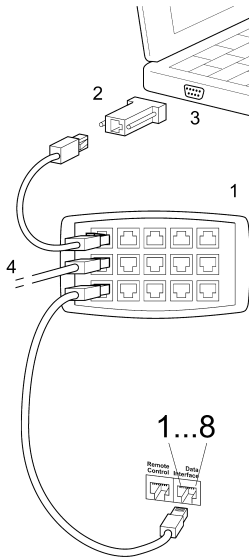

1. Cluster controller CC1
2. Interface adapter IA1
3. Computer connection (COM)
4. to fuel cartridge sensor FS1

A detailed description is available in the user manual for the cluster controller CC1.

Interface splitter:

The cluster controller splits the data interface and provides two sockets to connect the interface adapter and the fuel cartridge sensor together.



INFO :

A power supply is not available at the interfaces.

Parallel operation:

For high power requirements you can connect up to five devices in parallel using the optional cluster controller CC1. The devices switch charging mode on and off together.

Devices running in parallel must all be in the same operating mode (e.g. all in automatic mode) and the "External control" operating mode must be enabled.

All EFOY Pro fuel cells must have the same settings to run in parallel.

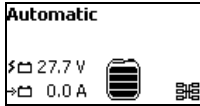

The cluster icon is displayed at the bottom right of the display for EFOY Pro devices running in parallel.

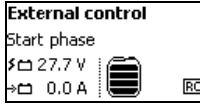

Remote control (remote-on):

The EFOY Pro can be controlled externally using a switching contact on the CC1, which means that the charging mode can be started.

The same function can also be enabled via the computer interface.

If the device is in "Remote Control" mode, "RC" (Remote Control) appears at the bottom right of the display.

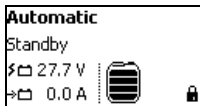

If you have not enabled external control, (see chapter 5.4 "Operating modes" on page 58), a padlock appears at the bottom right of the display.

A detailed description is available in the user manual Cluster Controller CC1.

8.6 DuoCartSwitch DCS 1

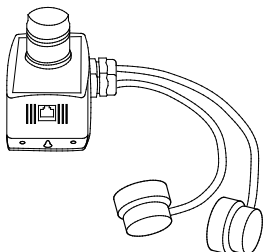

The DuoCartSwitch enables you to connect two fuel cartridges to the cartridge connector of one EFOY Pro fuel cell. The switching valve switches automatically from the fuel cartridge in operation to the reserve fuel cartridge. This means that the autonomy of the application can be doubled.

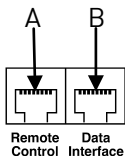

1. Screw the fuel-cartridge connector of the EFOY Pro on the DuoCartSwitch.
2. Connect one DuoCartSwitch via a port doubler to each RJ45-plug of the EFOY Pro:

- A: Remote Control plug
- B: Data Interface plug



CAUTION!

Only connect one DuoCartSwitch to each RJ45-plug (Remote Control / Data Interface).

If both DuoCartSwitch are connected to one RJ45-plug the switching of the DuoCartSwitch fuel connectors malfunctions, which might damage the EFOY Pro fuel cell.

3. For activation of the DuoCartSwitch see chapter 5.1 "Operation via the operating panel" on page 35.

A detailed description is available in the user manual DuoCartSwitch DCS1.

9 Appendix

9.1 Installation Checklist

Application: _____

EFOY Pro 12000 Duo S/N: _____

Date: _____

Technician: _____

#	Description	Note	OK
1	Initial Start Fluid filled in completely	Temperatures above +3 °C / +38 °F	
2	Fuel cell supplied with voltage	Check battery voltage and compare	
3	Language set	Adjustable in main menu	
4	Voltage profile set	Adjustable in expert menu	
5	Battery type set	Adjustable in expert menu	
6	Fuel cartridge and DuoCartSwitch set	Adjustable in main menu	
7	Altitude adjusted	Adjustable in expert menu	
8	EFOY Pro 12000 Duo started manually	Test run successful	
9	Air intake and off heat not blocked		
10	Exhaust hose not blocked	No kinks	

9.2 U-I and U-P characteristic

24 V DC:

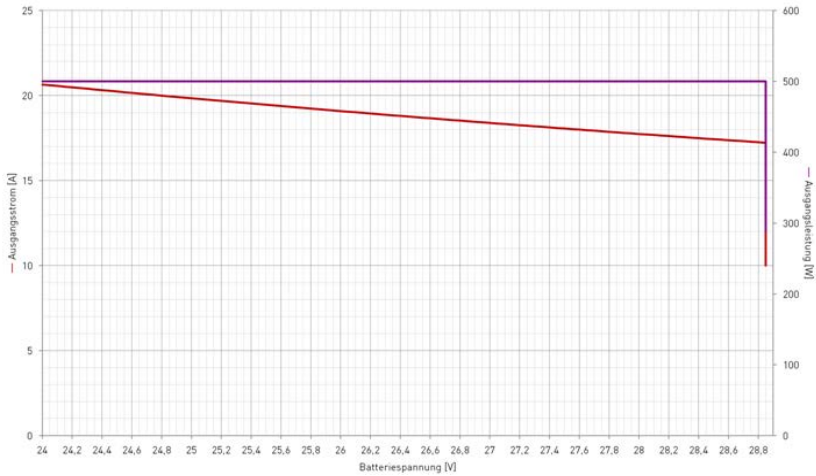

48 V DC:

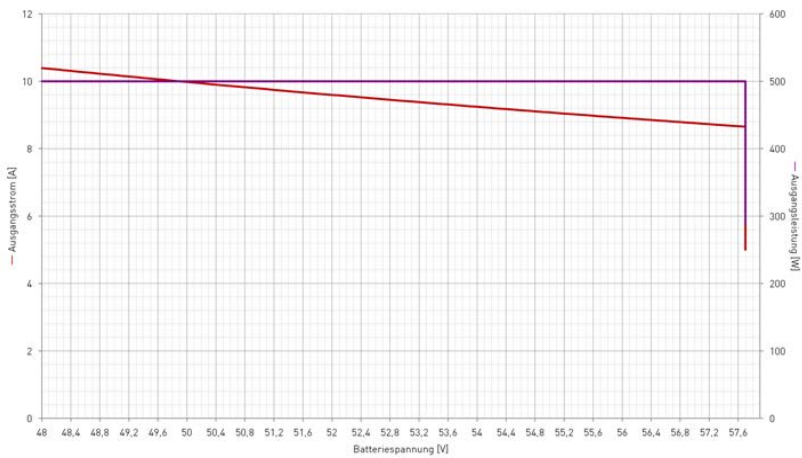

9.3 Output power characteristic

